

AKRO-MILS®



Materials...
Handled!™

TABLE OF CONTENTS

Storage Bins – Hanging & Stacking.....04-12

04 AkroBins	09 1800 Series AkroBins	12 Stak-N-Store Bins
06 Universal Hanging Bins	09 ESD AkroBins	
08 InSight Bins	10 Super-Size AkroBins	

Labeling13-15

13 Labels & Card Holders	14 Angle•Vu
14 Divider Label Tabs	15 Kanban Extended Label Holder

Storage Bins – Shelf Style.....16-22

16 Shelf Bins	20 Indicator Bins	22 Economy Bins
17 ShelfMax Bins	21 AkroDrawers	
18 ShelfMax8 Bins	22 System Bins	

Heavy-Duty Totes & Containers.....23-31

23 Attached Lid Containers, KeepBox	28 Multi-Load Tote	31 Gravity Hopper
24 Nest & Stack Totes (NST)	29 Straight Wall Containers (SWC)	
26 Akro-Grid	30 Akro-Tub, Cross-Stack Akro-Tub	

Bin Hanging Systems & Racks.....32-41

32 Louvered Panels	35 Benchtop Spinner Racks	38 Rail Hanging Systems
33 Louvered Peg Hooks	35 Louvered Bench Racks	39 Pick Racks
33 AkroShelf	36 Lean Panel, Lean Floor Rack	
34 Low-Profile Floor Racks	37 ReadySpace	

Small Parts Storage.....42-43

42 Storage Cases	43 ProBox Toolboxes	43 Tote Caddy
42 Portable Organizer	43 Roto-Shelf	

Cabinets44-55

44 TiltView Bins	48 Plastic Cabinets	52 TiltView Bin Cabinets
46 19 & 17 Series Cabinets	49 Ready-To-Assemble Cabinets	53 Secure Mini-Cabinets
47 Storage-Go-Round	49 Heavy-Duty Bin Cabinets	54 Stackable Cabinets
47 Mobile Rack	50 Standard Bin Cabinets	55 Super Modular Cabinets

Shelving Systems56-67

56 Wire Shelving Components	60 Wire Shelving Systems	64 Steel Shelving Systems
-----------------------------	--------------------------	---------------------------

Dollies68-71

68 Steel Dollies	70 Wood Dollies
69 Bin-Specific Steel Dollies	71 Plastic Dollies

Platform Trucks72-80

72 Platform Trucks, Wood	74 VERSA/Deck	79 Semi-Live Skids
73 Platform Trucks, Steel	76 ULTRA/Deck	80 Platform Trucks, Series 5
73 Platform Trucks, Super-Heavy-Duty	78 Platform Trucks, Work Height	

Carts & Work Centers81-87

81 ProCart	85 Box Carts	86 Mobile Work Tables
82 TiltView Stack Carts	85 Tray Service Carts	87 Heavy-Duty Work Benches
83 Louvered Cart	85 Super-Size AkroBin Carts	
84 Shelf Carts	86 Portable Tables & Carts	

Hand Trucks88-89

88 Heavy-Duty, Medium-Duty, Specialty	89 Dual-Purpose Hand Truck	89 Pail Truck
---------------------------------------	----------------------------	---------------

Bulk Handling90

90 Akro-Tilt Trucks	90 Akro-Carts
---------------------	---------------

Caster Descriptions91

Index92-94

Custom & OEM Capabilities.....95

NEW PRODUCTS:

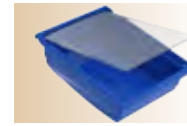

Universal Hanging Bins

See Pages 6-7



Louvered Benchtop Spinner Rack

See Page 35



Multi-Load Tote

See Page 28

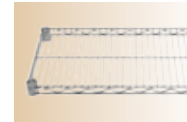

Wire Shelving Components

See Pages 56-58



Kanban Extended Label Holder

See Page 15

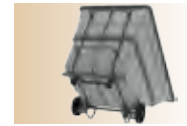

Akro-Tilt Trucks with Forklift Channels

See Page 90



ShelfMax8™

See Page 18

















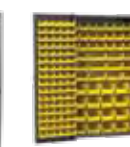

TiltView® Stack Cart

See Page 82

Look for this logo throughout our catalog to find the newest, innovative products from Akro-Mils!



TABLE OF CONTENTS

								
04 AkroBins	06 Universal Hanging Bins	08 InSight Bins	09 1800 Series AkroBins	09 ESD AkroBins	10 Super-Size AkroBins	12 Stak-N-Store	13 Labels & Card Holders	14 Divider Label Tab : Angle+Vu
								
15 Kanban Extended Label Holder	16 Shelf Bins	17 ShelfMax Bins	18 ShelfMax8 Bins	20 Indicator Bins	21 AkroDrawers	22 System Bins	22 Economy Bins	23 Attached Lid Containers : KeepBox
								
24 Nest & Stack Totes	26 Akro-Grids	28 Multi-Load Totes	29 Straight Wall Containers	30 Akro-Tubs : Cross-Stack Akro-Tubs	31 Easy Flow Gravity Hopper	32 Lowered Panels	33 AkroShelf	34 Low-Profile Floor Racks
								
35 Louvered Benchtop Spinner Racks	35 Louvered Bench Racks	36 Lean Panels : Lean Floor Rack	37 ReadySpace	38 Rail Hanging Systems	39 Pick Racks	42 Storage Cases	42 Portable Organizers	43 Toolboxes
								
43 Roto Shelf	43 Tote Caddy	44 TiltView Bins	46 19 & 17 Series Cabinets	47 Storage-Go-Round	47 Mobile Rack	48 Plastic Cabinets	49 Ready-to-Assemble Cabinet	49 Heavy-Duty Bin Cabinets
								
50 Standard Cabinets - Solid Door	51 Standard Cabinets - Quick-View Door	52 TiltView Bin Cabinets	53 Secure Mini-Cabinets	54 Stackable Cabinets	55 Super Modular Cabinets	56 Wire Shelving Components & Systems	62 Steel Shelving Systems	68 Steel Dollies
								
69 Bin-Specific Dollies	70 Wood Dollies	71 Polyethylene Dollies	72 Platform Trucks - Wood	73 Platform Trucks - Steel	74 VERSA/Deck	76 ULTRA/Deck	78 Platform Trucks - Work Height	79 Skids
								
80 Platform Truck - Series 5	81 ProCart	82 TiltView Stack Carts	83 Louvered Carts	84 Shelf & Multi-Shelf Carts	85 Box Carts	85 Tray Service Carts	85 Super-Size Bin Carts	86 Portable Tables & Carts
								
86 Mobile Work Tables	87 Heavy-Duty Work Benches	88 Hand Trucks	89 Dual-Purpose Hand Trucks	89 Pail Trucks	90 Akro-Tilt	90 Akro-Cart	91 Caster Information	92 Index



AkroBins®

INDUSTRY-LEADING HANGING & STACKING BINS



FEATURES

- 1 Anti-slide stop prevents stacked bins from shifting forward
- 2 Optional dividers allow you to create customizable compartment sizes
- 3 Full-width hanger lip supports bin on hanging system
- 4 Curved-bottom hopper front makes it easy to retrieve small parts
- 5 Reinforced side ribs add strength and prevent spreading when stacked
- 6 Large front label area for easy coding and scanning
- 7 Extra-wide stacking ledge provides stability, saves space and prevents spills



PRODUCT HIGHLIGHTS

- **EFFICIENT** – Control inventories, shorten assembly times, minimize parts handling
- **FUNCTIONAL** – Heavy-duty bins securely stack atop each other, sit on shelving, and hang from Akro-Mils racks, panels, rails and carts
- **DURABLE** – Molded of industrial-grade polymers, AkroBins are resistant to weak acids and alkalis. Water, rust and corrosion-proof
- **VARIETY** – Available in 15 sizes and 7 Standard Colors: Red, Blue, Yellow, Stone, Green, Black and Clear! 2 Specialty Colors: Light Blue and Purple available in 9 sizes; 3 Additional Colors: Hunter Green, Sandstone and Terra Cotta available in 8 sizes
- **GUARANTEED** – AkroBins are guaranteed not to crack or break under normal load conditions as stated in our 1-year limited warranty



STANDARD COLORS

Red, Yellow, Blue, Stone, Green, Clear, Black



SPECIALTY COLORS

Light Blue, Purple



ADDITIONAL COLORS

Hunter Green, Sandstone, Terra Cotta



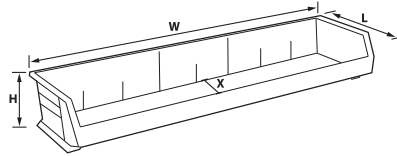
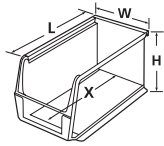

AkroBins Model No.	Outside Dimensions (In.)			Bottom Dimensions (In.)				Capacity/Quantity		Accessories							
	L	W	H	L	W	H	X	Bin Load Capacity On Rack	Bin Ctn. Qty.	Black Length Dividers‡	Black Width Dividers‡	Clear Length Dividers‡	Divider Pkg. Qty.	Bin Lids	Lid Pkg. Qty.	Adhesive Labels	Card Stock
30210* [§]	5-3/8	4-1/8	3	4-3/4	3-7/16	2-13/16	4	10 lbs.	24	40210 (1)	–	40210CRY	6	30211CRY	24	29202	29301
30220* [§]	7-3/8	4-1/8	3	6-3/4	3-7/16	2-13/16	6	10 lbs.	24	40220 (1)	–	40220CRY	6	30221CRY	24	29202	29301
NEW! 30237	9-1/4	6	5	8-9/16	4-7/8	4-3/4	7-1/4	20 lbs.	12	40237 (1)	–	40237CRY	6	–	–	29203	29302
30224*	10-7/8	4-1/8	4	10-1/4	3-3/16	3-3/4	9	20 lbs.	12	40224 (1)	–	40224CRY	6	30225CRY	12	29202	29301
30230* [§]	10-7/8	5-1/2	5	10-1/4	4-3/8	4-3/4	9	30 lbs.	12	40230 (1)	41230 (3)	40230CRY	6	30231CRY	12	29203	29302
30234* [§]	14-3/4	5-1/2	5	14-1/16	4-3/8	4-3/4	12-13/16	50 lbs.	12	40234 (1)	–	40234CRY	6	–	–	29203	29302
30239* [§]	10-3/4	8-1/4	7	10	6-9/16	6-3/4	8	50 lbs.	6	40239 (1)	–	40239CRY	6	–	–	29203	29302
30240* [§]	14-3/4	8-1/4	7	14	6-9/16	6-3/4	12	60 lbs.	12	40245 (1)	–	40245CRY	6	–	–	29203	29302
30265	18	8-1/4	9	17-1/8	6-3/4	8-1/4	14-1/2	60 lbs.	6	40265 (1)	–	40265CRY	6	–	–	29203	29303
30235*	10-7/8	11	5	10-1/4	10	4-3/4	9	50 lbs.	6	40230 (3)	–	40230CRY	6	30236CRY	6	29203	29302
30260	18	11	10	17	9-1/2	9-3/4	14-3/16	60 lbs.	6	40260 (3)	–	40260CRY	6	–	–	29203	29303
30255	10-7/8	16-1/2	5	9-3/4	15	4-3/4	9	60 lbs.	6	40230 (3)	–	40230CRY	6	–	–	29203	29302
30250* [§]	14-3/4	16-1/2	7	14	14-3/4	6-3/4	12	75 lbs.	6	40245 (3)	41250 (6)	40245CRY	6	–	–	29203	29302
30270	18	16-1/2	11	17-1/8	14-3/4	10-1/4	14	75 lbs.	3	40270 (3)	41270 (6)	40270CRY	6	–	–	29203	29303
30320	8-5/8	33	5	7	31-1/2	4-3/16	6	80 lbs.	4	40321 & 40220 (7)	–	40220CRY	7/6	30321	4	–	–

One color per carton: Specify Red, Blue, Yellow, Stone, Clear, Green or Black. Order in carton quantities. CAUTION: When using bins with hanging systems, do not exceed the weight capacity for the rack, which may be less than the total sum of bin capacities. 40321= Tall Divider; 40220=Short Divider. *Available in Specialty Colors: Purple and Light Blue. †Available in Additional Colors: SS = Sandstone, TC = Terra Cotta and HG = Hunter Green. ‡() = Max. # of divider slots per bin. 30211CRY replaces 30211; 30221CRY replaces 30221; 30231CRY replaces 30231; 30236CRY replaces 30236.

ACCESSORIES



Crystal Clear Length Dividers
Fewer shadows make parts easier to find



See-Through Crystal Clear Lids
Keep contents dust-free and protected

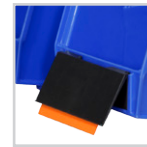

Kanban Extended Label Holders
Turn your bin storage system into a complete Kanban system (See page 15)



Length Dividers
Keep items separated in bin. Now available for all sizes!



Adhesive Labels & Card Stock Holders
Clearly identify bin contents. (See page 13)



Width Dividers
Available for 30230, 30250 and 30270



Bin Retainer Clip Model No. 40599
Holds any size AkroBin securely on louvered panels. Perfect for service vans and maintenance workers, plumbers, electricians or other tradespeople who store and transport supplies and materials

RELATED PRODUCTS

Create the perfect storage system – mix and match your selection of AkroBins with compatible products





Universal Hanging Bins

VERSATILE, NESTABLE BINS HANG FROM ALL 4 SIDES



NEW!



FEATURES

- 1 Sloped-side hanging lip lets bin hang at an angle for maximum visibility and part access
- 2 Flat-side hanging lip keeps bin level when hanging
- 3 Rear hanglock allows bin to tilt out on steel or wire shelving units
- 4 Divider slot provides additional storage options
- 5 Integrated lid holes allow for easily attaching optional Crystal Clear Dust Protection Lids; lids attach at either end of the bin
- 6 Bin widths are sized to maximize storage space on standard width steel and wire shelving units

PRODUCT HIGHLIGHTS

- **VERSATILITY** – Moves seamlessly from shelving to louvers to rails, changing from a sloped bin to a regular profile with a 180° turn.
- **NESTABLE** – Universal Bins nest when empty to conserve space
- **VARIETY** – Available in 7 sizes and 4 colors: Red, Blue, Yellow and Clear



COLORS

Red, Yellow, Blue, Clear



AVAILABLE IN
CLEAR
CRYSTAL



36130



Hanging from the back creates a sloped picking bin without a pick rack, keeping parts visible and accessible



Hanging from the front creates a flat bin profile



Hanging from the side provides space savings in the work area. (Louvered panels only)

Hanging Sloped

Hanging Straight

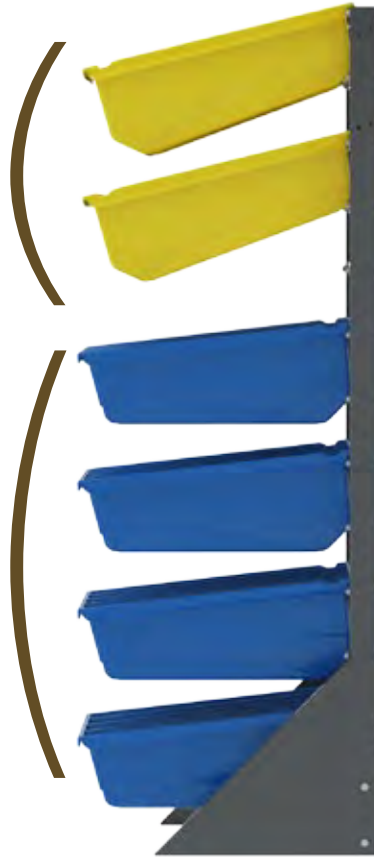

36230 shown with 30008 Rail Rack

Universal Hanging Bins	Outside Dimensions (In.)			Inside Dimensions (In.)			Quantity	Accessories			
	Model No.	L	W	H	L	W		H	Bin Ctn. Qty.	Dividers	Divider Pkg. Qty.
36110	11-1/2	4-1/8	4-1/2	9-5/8	2-9/16	4-5/16	16	46110	12	36111CRY	8
36120	11-1/2	6-5/8	4-1/2	9-5/8	5-1/16	4-5/16	10	46110	12	36121CRY	10
36130	11-1/2	8-1/4	4-1/2	9-5/8	6-11/16	4-1/4	8	46110	12	36131CRY	8
36140	11-1/2	11	4-1/2	9-5/8	9-7/16	4-1/4	6	46110	12	36141CRY	6
36220	17-1/2	6-5/8	6-1/2	15-1/4	4-3/4	6-1/4	10	46220	6	36221CRY	10
36230	17-1/2	8-1/4	6-1/2	15-1/4	6-3/8	6-1/4	8	46220	6	36231CRY	8
36240	17-1/2	11	6-1/2	15-1/4	9-1/8	6-1/4	6	46220	6	36241CRY	6

One color per carton: Specify Red, Blue, Yellow or Clear. Order in carton quantities. CAUTION: When using bins with hanging systems, do not exceed the weight capacity for the rack.

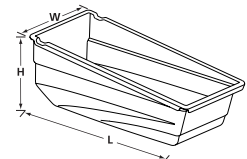

ACCESSORIES



Length Dividers
Available for all sizes



Lids
Attach at either end of the bin



Adhesive Labels
Clearly identify bin contents. (See page 13)

InSight®

ULTRA-CLEAR POLYCARBONATE BINS



FEATURES

- 1 Unique “lock-in-place” design for secure stacking
- 2 Strong molded hanger supports bins on hanging systems
- 3 Large label area for part identification and bar code scanning
- 4 Optional lids (sold separately) protect contents from dust. Will stack with lids in place!
- 5 Clear length and width dividers available (sold separately)



COLOR
Clear



PRODUCT HIGHLIGHTS

- **VISIBILITY** – Bins provide easy and maximum visibility of parts and supplies
- **FUNCTIONAL** – Bins securely stack, and hang from louvered panels, rails and the ReadySpace® Storage System
- **NO-TIP FEATURE** – Patent-pending design: Bins won't tip when stacked!
- **DURABLE** – Products made of high-impact polycarbonate are autoclavable up to 250° F
- **VARIETY** – Available in 4 sizes



InSight Model No.	Outside Dimensions (In.)			Inside Dimensions (In.)			Capacity/Quantity		Accessories					
	L	W	H	L	W	H	Capacity (lbs.)	Bin Ctn. Qty.	Width Divider*	Divider Pkg Qty.	Length Divider*	Divider Pkg Qty.	Lid	Lid Pkg Qty.
305A1	5-3/8	4-1/8	3-1/4	4-1/4	3-1/8	2-5/8	10	16	415A1 (1)	8	405A1 (1)	8	305A2	16
305A3	7-3/8	4-1/8	3-1/4	6-1/4	3-1/8	2-5/8	10	16	415A1 (2)	8	405A3 (1)	8	305A4	16
305A5	10-7/8	4-1/8	3-1/4	9-1/4	3-1/8	2-5/8	15	12	415A1 (3)	8	405A5 (1)	6	305A6	12
305B1	10-7/8	5-1/2	5-1/4	9-7/16	4-1/8	4-7/16	25	12	415B1 (3)	6	405B1 (1)	6	305B2	12

*() = Max. # of divider slots per bin.

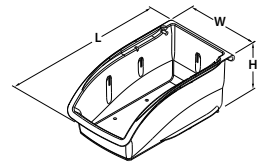

ACCESSORIES



Lids
Protect bin contents from dust



Dividers
Expand sorting options with length dividers

RELATED PRODUCTS

Create the perfect storage solution — mix and match your InSight Bins with these products



32-36 Louvered Hanging Systems



37 ReadySpace Storage Systems



38 Rail Hanging Systems

1800 Series AkroBins® : ESD Containers

SPECIALTY AKROBINS



1800 Series AkroBins®

STACKABLE SHELF BINS



- **DURABLE** – Strong industrial-grade polymer construction
- **STACKING** – Stackable storage systems for large, heavy or bulky items
- **DIVIDABLE** – One black width divider included per bin



30348

COLOR
Beige



1800 Series	Outside Dimensions (In.)			Inside Dimensions (In.)							
Model No.	L	W	H	L	W	H	X	Ctn. Qty.	Dividers	Pkg. Qty.	Capacity (Lbs.)
30348BEIGE	20-1/2	8-1/4	7	20	7-3/8	6-1/2	20	6	40348 (3)	6	60
30358BEIGE	20-1/2	11	7	20	10-1/8	6-1/2	20	6	40358 (3)	6	75

Available in Beige. Order in carton quantities.

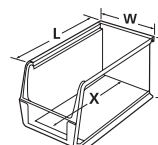

ESD Containers

AKROBINS MADE WITH ELECTROSTATIC DISSIPATIVE MATERIALS



- **PROTECTION** – Dissipate electrostatic charges, which can severely damage sensitive electronic components
- **OHM RATING** – Static Dissipative Range 10^4 to 10^{11} ohms/sq.
- **LOW CARBON** – 1% - 2% carbon content - won't leave residue on parts



30235



COLOR
Black



ESD Containers	Outside Dimensions (In.)			Inside Dimensions (In.)					
Model No.	L	W	H	L	W	H	X	Cap. on Rack	Ctn. Qty.
30210ESD	5-3/8	4-1/8	3	4-3/4	3-7/16	2-13/16	4	10 lbs.	24
30220ESD	7-3/8	4-1/8	3	6-3/4	3-7/16	2-13/16	6	10 lbs.	24
30230ESD	10-7/8	5-1/2	5	10-1/4	4-3/8	4-3/4	9	30 lbs.	12
30235ESD	10-7/8	11	5	10-1/4	10	4-3/4	9	50 lbs.	6
30240ESD	14-3/4	8-1/4	7	14	6-9/16	6-3/4	12	60 lbs.	12

Available in Black. Order in carton quantities.

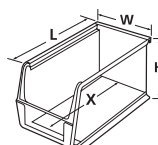

30210
30220



Super-Size AkroBins®

INDUSTRY-LEADING LARGE-CAPACITY STACKING BINS



MADE IN THE USA

30292

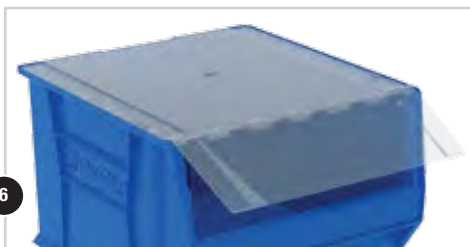

COLORS

Red, Yellow, Blue, Clear, Gray



30290M0B



FEATURES

- 1 Reinforced side ribs add strength and prevent spreading when stacked
- 2 Anti-slide stop prevents stacked bins from shifting forward
- 3 Large label area on front of bin
- 4 Divider slots help create separate compartments
- 5 Easy to carry with large handle molded onto back of bin
- 6 **NEW FEATURE** - Optional hinged lid covers and protects while allowing access to contents *even when bins are stacked*

PRODUCT HIGHLIGHTS

- **CAPACITY** – Large-capacity storage to improve organization and workflow
- **STACKABLE** – Heavy-duty bins securely stack atop each other, sit on shelving, carts or dollies; bins can stack with casters attached
- **DURABLE** – Molded of industrial-grade polymers, Super-Size AkroBins are resistant to weak acids and alkalis. Water, rust and corrosion-proof
- **VARIETY** – Available in 12 sizes and 5 colors: Red, Blue, Yellow, Clear, Gray
- **GUARANTEED** – Super-Size AkroBins are guaranteed not to crack or break under normal load conditions as stated in our 1-year limited warranty

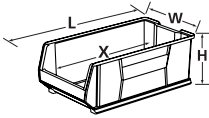

Super-Size AkroBins	Outside Dimensions (In.)			Inside Dimensions (In.)				Capacity/Quantity			Accessories									
	Model No.	L	W	H	L	W	H	X	Max. Cap. per Bin	Stacking Cap./= Qty. Stacked	Ctn. Qty.	Width Dividers*	Length Dividers*	Divider Pkg. Qty. W L	Bin Lids	Lid Pkg. Qty.	Windows	Window Pkg. Qty.	Card Stock Holder	
30280	20	12-3/8	6	16-7/8	10-11/16	5-3/8	15-1/2	200 lbs.	40 lb./10	4	-	40280 (3)	-	2	30280L	4	21280	2	29304	
30281	20	12-3/8	8	16-7/8	10-11/16	7-3/8	15-1/2	200 lbs.	50 lb./7	3	-	40281 (3)	-	3	30281L	3	21281	3	29304	
30282	20	12-3/8	12	16-7/8	10-11/16	11-3/8	15-1/2	200 lbs.	60 lb./5	2	-	40282 (3)	-	1	30282L	2	21282	2	29304	
30283	20	18-3/8	12	16-7/8	16-9/16	11-3/8	15-1/2	300 lbs.	150 lb./5	1	-	40282 (3)	-	1	30283L	1	21283	1	29304	
30284	23-7/8	8-1/4	7	20-7/8	6-3/8	6-1/8	19-3/8	200 lbs.	150 lb./5	4	41284 (2)	40286 (1)	2	4	-	-	21284	4	29304	
30286	23-7/8	11	7	20-7/8	9-1/8	6-1/8	19-5/16	200 lbs.	150 lb./5	4	41286 (2)	40286 (3)	2	4	30286L	4	21286	4	29304	
30287	23-7/8	11	10	20-3/4	9	9-1/8	19-5/16	300 lbs.	150 lb./5	4	41287 (2)	40287 (3)	6	6	-	-	21287	4	29304	
30288	23-7/8	16-1/2	11	20-3/4	14-3/8	10-1/8	19-5/16	300 lbs.	150 lb./5	1	41288 (2)	40287 (3)	6	6	-	-	21288	1	29304	
NEW! 30288MOB†	Mobile 30288 bin with 3" locking casters**								200 lbs.	-	1	41288 (2)	40287 (3)	6	6	-	-	21288	1	29304
30289	23-7/8	18-1/4	12	20-3/4	16	11-1/8	19-1/4	300 lbs.	150 lb./5	1	41289 (2)	40289 (3)	2	1	-	-	21289	1	29304	
NEW! 30289MOB†	Mobile 30289 bin with 3" locking casters**								200 lbs.	-	1	41289 (2)	40289 (3)	2	1	-	-	21289	1	29304
30290	29-1/4	18-3/8	12	26-1/8	16-9/16	11-3/8	24-3/4	300 lbs.	150 lb./5	1	-	40290 (3)	-	1	30290L	1	21283	1	29304	
NEW! 30290MOB†	Mobile 30290 bin with 3" locking casters**								200 lbs.	-	1	-	40290 (3)	-	1	-	-	21283	1	29304
30292	29-7/8	11	10	26-3/4	9	9-1/8	25-5/16	300 lbs.	150 lb./5	4	41287 (2)	40292 (3)	6	6	-	-	21287	4	29304	
NEW! 30292MOB†	Mobile 30292 bin with 3" locking casters**								200 lbs.	-	4	41287 (2)	40292 (3)	6	6	-	-	21287	4	29304
30293	29-7/8	16-1/2	11	26-3/4	14-3/8	10-1/8	25-5/16	300 lbs.	150 lb./5	1	41288 (2)	40292 (3)	6	6	-	-	21288	1	29304	
NEW! 30293MOB†	Mobile 30293 bin with 3" locking casters**								200 lbs.	-	1	41288 (2)	40292 (3)	6	6	-	-	21288	1	29304

One color per carton: Specify Red, Blue, Yellow, Clear or Gray. Not recommended to hang on rack or panel systems. Order in carton quantities. * () = Max. # of divider slots per bin. †Assembly required. **Add 3" to overall height of bin with casters.

ACCESSORIES



Hinged Lids
Available for 6 bin models



Length Dividers
Available for all sizes



Mobile Kit
Go mobile! Transport your heaviest parts and supplies



Window Insert
Optimizes interior space and keeps contents visible



Width Dividers
Available for 7 bin models



Adhesive Labels & Card Stock Holders
Card Stock Holders fit in bins' existing slot; adhesive labels also available. See page 13

RELATED PRODUCTS
Increase the benefits of your Super-Size AkroBins with the following products



61-63 Wire Shelving Systems



64-67 Steel Shelving Systems



69 Dollies



85 Super-Size Bin Carts



Stak-N-Store Bins

STACKABLE BINS PERFECT FOR HEAVY, BULKY ITEMS



COLORS
Red, Blue, White, Clear, Gray



FEATURES

- 1 Large radius corners and rolled rim add strength
- 2 Side ribs add stability when stacked
- 3 Wide hopper front allows easy access to bulky items
- 4 Large comfort grip handles



PRODUCT HIGHLIGHTS

- **STACKBLE** – Bins stack to form tall, stable storage arrangements on floors or standard industrial shelving
- **CAPACITY** – 75-lb. weight capacity
- **DURABLE** – Durable, industrial-grade polymer will not rust, corrode or bend out of shape even when fully loaded
- **COST-EFFECTIVE** – Longer service life resulting in lower replacement costs
- **VARIETY** – Available in 3 sizes and 5 colors: Red, Blue, Gray, White, Clear



Stak-N-Store Bins Model No.	Outside Dimensions (In.)			Inside Dimensions (In.)				Capacity/Quantity				
	L	W	H	L	W	H	X	Cu. Ft.	Gal	Lbs.	Stacking Height	Ctn. Qty.
13014	17-1/2	10-7/8	12-1/2	15-5/8	8	12-1/4	13-1/2	.98	7.4	75	3	4
13017*	15-1/4	19-7/8	12-7/16	13-5/8	17-1/2	12-1/4	11-1/2	1.7	12.7	75	3	3
13018	17-1/2	16-1/2	12-1/2	15-5/8	13-3/4	12-1/4	13-1/2	1.6	12	75	3	2

One color per carton. Specify Red, Blue, Gray or Clear. *13017 also available in White. Order in carton quantities.

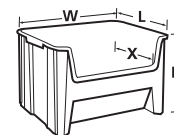

RELATED PRODUCTS

Add mobility to your Stak-N-Store Bins with



61-63 Wire Shelving Systems



64-67 Steel Shelving Systems



69 Dollies

Adhesive Labels & Card Holders

LABELING OPTIONS FOR BINS, TOTES, CONTAINERS



VIDEO ONLINE **PRODUCT HIGHLIGHTS**

- **FUNCTIONAL** – Can be used on a variety of Akro-Mils bins, totes and containers
- **EFFICIENT** – Perfect for 5S Lean and other productivity initiatives
- **VARIETY** – Card Stock Holders, Adhesive Labels, Adhesive Backed Card Holders available

Adhesive Labels - 29200, 20201, 20202, 29203

- Designed to fit inside card slot areas on Akro-Mils AkroBins®, ShelfMax® Bins and Shelf Bins
- Acrylic adhesive backing forms permanent bond with bins
- Can be used on a wide range of Akro-Mils bins, totes and containers, including AkroDrawers®, Super-Size AkroBins®, Universal Hanging Bins, ShelfMax8™, and Stak-N-Store Bins

Card Stock Holders - 29300, 20301, 20302, 29303

- Fit in bin's existing card holder slot
- Card stock labels identify contents of bin

Adhesive Backed Card Holder - 20304

- Features an adhesive back to work with bins that do not have card holder slots, such as Super-Size AkroBins, 33" Wide AkroBins, Akro-Tubs, NSTs, ALCs, SWCs and Stak-N-Store Bins, ShelfMax8
- 2 5/8" x 3 3/8" surface area required



30230 with 20203



30240 with 20303



30292 with 29304

Adhesive Labels		Dimensions (In.)		Works With:	Labels Per Sheet	Pkg. Qty.	Total Labels
Model No.	W	H					
29200	1-5/8	3/4	30110 Shelf Bin	36	10 Sheets	360	
29201	2-5/8	3/4	30120, 30130, 30150, 30170, 30128, 30138, 30158, 30178, 30124, 30164, 30184, 30174 Shelf Bins	24	10 Sheets	240	
29202	2-5/8	7/8	30210, 30220, 30224 AkroBins; All ShelfMax Bins; All Indicator Bins	20	10 Sheets	200	
29203	3-5/8	1-5/8	30230, 30234, 30235, 30239, 30240, 30250, 30255, 30260, 30265, 30270 AkroBins; AkroDrawers; Super-Size AkroBins; Universal Bins; ShelfMax8 Bins; Attached Lid Containers; Nest & Stack Totes; Stak-N-Store Bins	12	10 Sheets	120	

The labels were designed to fit inside our card slot area and have an acrylic adhesive backing. The approximate time for permanent bond is 48-72 hours.

Card Stock Holder		Dimensions (In.)		Works With:	Cards Per Sheet	Sheets Per Pack	Total Cards Per Pack	Total # of Clear Holders
Model No.	W	H						
29300	3	13/16	All 4" Shelf Bins**	24	3	72	25	
29301	3	1	30210, 30220, 30224, All ShelfMax Bins	20	3	60	25	
29302	4	1-3/4	30230, 30234, 30235, 30239, 30240, 30250, 30255, 30348, 30358	12	3	36	25	
29303	4	2	30260, 30265, 30270, 33223	12	3	36	25	
29304*	3-1/2	2	All Super-Size Akro-Bins, ShelfMax8 Bins, and items without Card Slots – adhesive strip on back	10	3	30	25	

The clear holders for the 29300 - 29303 fit in our card slot holder. *The 29304 has an adhesive back and will work with multiple sizes of products that do not have a card slot holder such as Super-Size AkroBins, 33" Wide AkroBins, Universal Bins, ShelfMax8 Bins, Attached Lid Containers, Nest & Stack Totes, Straight Wall Containers or Stak-N-Store Bins. **Excluding 30110 (29300 can be cut to length) 1%.

RELATED PRODUCTS

Adhesive Labels and Card Holders work with



4-5 AkroBins

6-7 Universal Hanging Bins

10-11 Super-Size AkroBins

16 Shelf Bins

17 ShelfMax

18 ShelfMax8

Divider Label Tab : Angle•Vu™ Adjustable Label Holder

5S LABELING SOLUTIONS

Divider Label Tab

CLEARLY IDENTIFY BIN CONTENTS IN SEPARATE COMPARTMENTS



30130 with 40130 Dividers & 40000 Label Tabs



MADE IN THE USA



- **VERSATILE** – Works with Akro-Mils bin width dividers
- **COMPACT** – Designed to sit nearly flush with the top of Shelf Bins and ShelfMax Bins, and will not get in the way on shelving
- **FUNCTIONAL** – Easily fits 1" x 3" adhesive label

Divider Label Tab		Dimensions (In.)			Accessories	
Model No.	Description	W	L	D	Ctn. Qty.	Adhesive Labels
40000	Divider Label Tab	2-3/4	3-1/8	1/2	6	29201, 29202

Angle•Vu™ Adjustable Label Holder

NO MORE CLIMBING OR BENDING TO READ OR SCAN A LABEL!



- **ADJUSTABLE** – Allows the label face to be pointed upward on low shelves and downward on high shelves
- **VERSATILE** – Works with all Akro-Mils wire shelving



Angle•Vu	Dimensions (In.)		Cards Per Sheet		Total No.	
Model No.	W	H	Cards Per Sheet	Sheets Per Pack	Cards Per Pack	Label Holders
29306	3	1-1/4	16	3	48	25

Kanban Extended Label Holders

TURN ANY BIN STORAGE SYSTEM INTO A COMPLETE KANBAN SYSTEM



NEW!



FEATURES

- 1 Orange Kanban flag *slides out* to indicate bin needs refilled
- 2 Extra-large label holder face accepts up to 2" x 4" adhesive label (Akro-Mils 29203 recommended)
- 3 Converts AkroBins®, 4" Shelf Bins, 6" ShelfMax® Bins, or 1800 Series AkroBins® into a single-bin Kanban system
- 4 Can be used on bins with the large label area facing upward or downward for easy viewing and scanning

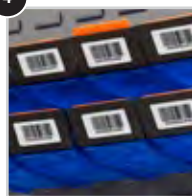
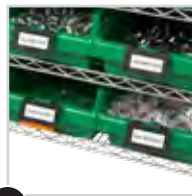

Extended Label Holders		
Model No.	Description	Ctn. Qty.
40411	Kanban Label Holder - works with 30210, 30220, 30224 AkroBins, 4" Shelf Bins*, 6" ShelfMax Bins	24
40412	Kanban Label Holder - works with all AkroBins except 30210, 30220, 30224, 30320; works with 1800 Series AkroBins	24
40410**	Standard Label Holder, no flag - works with 4" Shelf Bin*, 6" ShelfMax	24

*Does not work with 30110. **Not reversible for high shelf viewing.

STANDARD LABEL HOLDER



40410 shown with 30130

RELATED PRODUCTS

Kanban Extended Label Holders work with



4-5 AkroBins

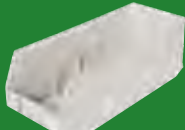

9 1800 Series AkroBins

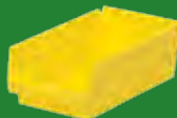

16 Shelf Bins



17 ShelfMax



Shelf Bins

INDUSTRY-LEADING 4" HIGH SHELF BINS ARE DURABLE, EFFICIENT

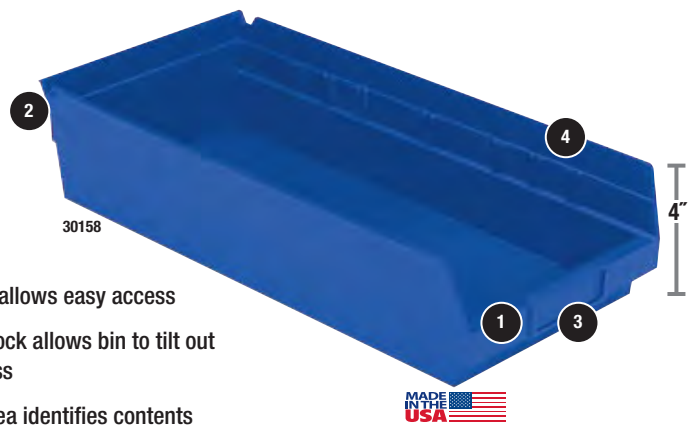

FEATURES

- 1 Wide hopper front allows easy access
- 2 Built-in rear hanglock allows bin to tilt out for complete access
- 3 Molded-in label area identifies contents
- 4 Each bin accepts up to 7 dividers (except 30110)

PRODUCT HIGHLIGHTS

- **EFFICIENT** – Shelf Bins work with 12", 18" and 24" deep shelving, pick racks or vertical storage and retrieval units
- **DURABLE** – Industrial-grade polymer bins outlast corrugated bins — paying for themselves in reduced replacement costs. Bins won't spread or crack when loaded. One-piece construction is waterproof and resistant to grease or oil
- **NESTABLE** – Shelf Bins nest when empty to conserve space
- **VARIETY** – Available in 13 sizes and 6 colors: Red, Blue, Yellow, Green, White and Clear

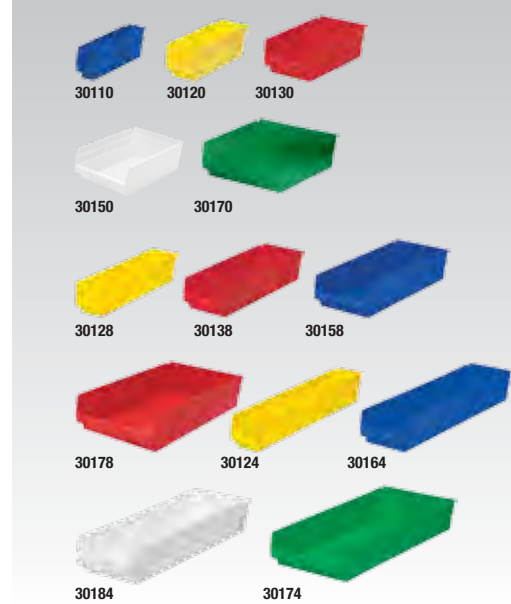

STANDARD COLORS

Red, Yellow, Blue, Green, White, Clear



ADDITIONAL COLORS

Hunter Green, Sandstone, Terra Cotta



Shelf Bins	Outside Dimensions (In.)			Inside Dimensions (In.)			Capacity/Quantity		Cups per Bin		Accessories				
	Model No.	L	W	H	L	W	H	Cubic Inches	Ctn. Qty.	Small 30101	Large 30102	Width Dividers*	Divider Pkg. Qty.	Labels	Card Stock
30110 [§]	11-5/8	2-3/4	4	10-1/4	1-5/8	4	54	24	3	—	—	—	—	29200	29300**
30120 [§]	11-5/8	4-1/8	4	10-1/4	3	4	78	24	5	2	40120 (7)	24	29201	29300	
30130 [§]	11-5/8	6-5/8	4	10-1/4	5-1/2	4	128	12	9	4	40130 (7)	24	29201	29300	
30150 [§]	11-5/8	8-3/8	4	10-1/4	7-1/8	4	138	12	11	4	40150 (7)	24	29201	29300	
30170	11-5/8	11-1/8	4	10-1/4	10	4	197	12	15	6	40170 (7)	24	29201	29300	
30128 [§]	17-7/8	4-1/8	4	16-1/2	3	4	123	12	8	3	40120 (7)	24	29201	29300	
30138 [§]	17-7/8	6-5/8	4	16-1/2	5-1/2	4	176	12	15	6	40130 (7)	24	29201	29300	
30158	17-7/8	8-3/8	4	16-1/2	7-1/8	4	214	12	15	6	40150 (7)	24	29201	29300	
30178	17-7/8	11-1/8	4	16-1/2	10	4	292	12	25	12	40170 (7)	24	29201	29300	
30124 [§]	23-5/8	4-1/8	4	22-1/8	3	4	199	12	11	4	40120 (7)	24	29201	29300	
30164 [§]	23-5/8	6-5/8	4	22-1/8	5-1/2	4	321	6	21	8	40130 (7)	24	29201	29300	
30184	23-5/8	8-3/8	4	22-1/8	7-1/8	4	346	6	25	8	40150 (7)	24	29201	29300	
30174	23-5/8	11-1/8	4	22-1/8	10	4	513	6	35	16	40170 (7)	24	29201	29300	

One color per carton: Specify Red, Blue, Yellow, Green, White or Clear. [§]Available in Additional Colors: SS = Sandstone, TC = Terra Cotta and HG = Hunter Green. Order in carton quantities. * () = Max. # of divider slots per bin. **29300 must be cut to length to fit 30110.

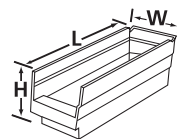

ACCESSORIES



Width Dividers
Available for all sizes (except 30110)



Kanban Extended Label Holders
Turn your bin storage system into a complete Kanban system (see page 15)

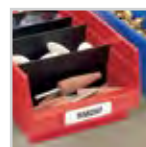

Adhesive Labels & Card Stock Holders
Card stock holders fit in bins' existing slot; Adhesive labels also available (see page 13)



Bin Cups
Lift out easily for parts retrieval (see chart)

Bin Cups	Outside Dimensions (In.)			Ctn. Qty.
Model No.	L	W	H	
30101	2	3-1/4	3	48
30102	2-3/4	5	3	24

ShelfMax® Bins

6" HIGH SHELF BINS MAXIMIZE STORAGE CAPACITY

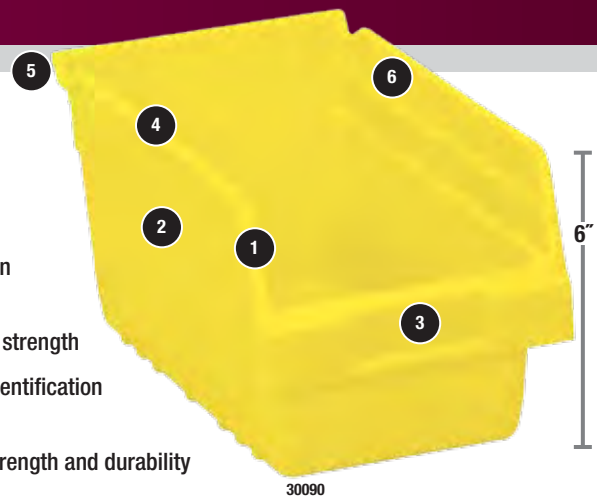

FEATURES

- 1 Front opening is 3/4" higher than comparable 6" products
- 2 Reinforced side ribs for added strength
- 3 Large label area aids in part identification and bar code scanning
- 4 Rolled ridge provides added strength and durability when filled to capacity
- 5 Built-in rear hanglock allows bin to tilt out for complete access
- 6 Optional dividers create additional storage options

PRODUCT HIGHLIGHTS

- **CAPACITY** – Bins offer 85% more storage than traditional 4" bins
- **EFFICIENT** – Works with steel shelving, wire shelving, pick racks and bench racks
- **DURABLE** – Superior construction compared to corrugated bins
- **VARIETY** – Available in 12 sizes and 4 colors: Red, Blue, Yellow and Clear

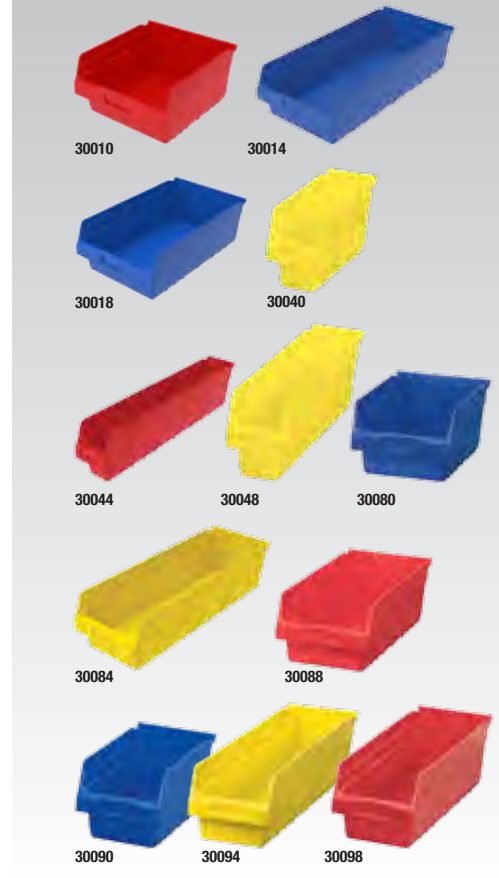

COLORS

Red, Yellow, Blue, Clear

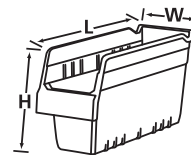

ShelfMax	Outside Dimensions (In.)			Inside Dimensions (In.)			Capacity/Quantity		Accessories		
	Model No.	L	W	H	L	W	H	Cubic Inches	Ctn. Qty.	Width Dividers*	Divider Pkg. Qty.
30040	11-5/8	4-1/8	6	9-3/4	2-1/2	5-15/16	175	16	40020 (7)	12	29301
30090	11-5/8	6-5/8	6	9-3/4	5	5-15/16	310	10	40030 (7)	12	29301
30080	11-5/8	8-3/8	6	9-3/4	6-5/8	5-15/16	398	8	40040 (7)	12	29301
NEW! 30010	11-5/8	11-1/8	6	9-3/4	9-1/2	5-15/16	591	8	40050 (7)	12	29301
30048	17-7/8	4-1/8	6	16	2-1/2	5-15/16	280	8	40020 (7)	12	29301
30098	17-7/8	6-5/8	6	16	5	5-15/16	505	10	40030 (7)	12	29301
30088	17-7/8	8-3/8	6	16	6-5/8	5-15/16	648	8	40040 (7)	12	29301
NEW! 30018	17-7/8	11-1/8	6	16	9-1/2	5-15/16	963	8	40050 (7)	12	29301
NEW! 30044	23-5/8	4-1/8	6	21-3/4	2-1/2	5-15/16	410	16	40020 (7)	12	29301
30094	23-5/8	6-5/8	6	21-3/4	5	5-15/16	686	10	40030 (7)	12	29301
NEW! 30084	23-5/8	8-3/8	6	21-3/4	6-5/8	5-15/16	935	6	40040 (7)	12	29301
NEW! 30014	23-5/8	11-1/8	6	21-3/4	9-1/2	5-15/16	1303	6	40050 (7)	12	29301

One color per carton: Specify Red, Blue, Yellow, Green, White or Clear. Order in carton quantities. * () = Max. # of divider slots per bin.

ACCESSORIES

Width Dividers
Available for all sizes

Adhesive Labels & Card Stock Holders
Card stock holders fit in bins' existing slot; Adhesive labels also available. (See page 13)

Kanban Extended Label Holders
Turn your bin storage system into a complete Kanban system (See page 15)

RELATED PRODUCTS

Create the perfect storage solution — mix and match your ShelfMax Bins with these products



39-41 Pick Rack Systems



61-63 Wire Shelving Systems



64-67 Steel Shelving Systems



ShelfMax8™ Bins

EXTRA-LARGE, 8-INCH HIGH, FOR MAXIMUM STORAGE CAPACITY

NEW!



30800



FEATURES

- 1 Bins feature a wide hopper front for easy access and a built-in rear hanglock to allow complete access to contents when tilted out on shelving
- 2 The oversized label area easily accommodates a 2' high adhesive label, or multiple adhesive labels for divided bins holding multiple SKUs
- 3 An innovative new divider design allows for more secure bin partitions along with easier installation and removal

PRODUCT HIGHLIGHTS

- **VERSATILE** – Sizes designed for standard shelving systems and many Vertical Carousel Automated Storage Retrieval Systems
- **CAPACITY** – Up to 95% more holding capacity than traditional 4" shelf bins, and 65% more capacity than 6" bins
- **VARIETY** – Available in 23 sizes and 4 colors: Red, Blue, Yellow and Clear



COLORS

Red, Yellow, Blue, Clear



AVAILABLE IN
CLEAR



30860

ShelfMax8[®] Bins

ShelfMax8 Model No.	Outside Dimensions (In.)			Inside Dimensions (In.)			Capacity/Quantity			Accessories			
	L	W	H	L	W	H	Cubic Inches	U.S. Gal.	Ctn. Qty.	Width Dividers*	Divider Pkg. Qty.	Length Dividers*	Divider Pkg. Qty.
30840	11-5/8	4-1/8	8	9-3/8	2-9/16	7-15/16	233	1.01	16	40840 (7)	12	-	-
30860	11-5/8	6-5/8	8	9-3/8	5	7-15/16	411	1.78	10	40860 (7)	12	-	-
30880	11-5/8	8-1/4	8	9-3/8	6-5/8	7-15/16	520	2.25	8	40880 (7)	12	-	-
30800	11-5/8	11-1/8	8	9-3/8	9-7/16	7-15/16	734	3.18	4	40800 (7)	12	-	-
30820	11-5/8	22-1/2	8	8-15/16	20-1/4	7-15/16	1638	7.09	4	40820 (7)	6	41820 (7)	12
30846	15-5/8	4-1/8	8	13-3/8	2-9/16	7-15/16	332	1.44	8	40840 (7)	12	-	-
30866	15-5/8	6-5/8	8	13-3/8	5	7-15/16	585	2.53	10	40860 (7)	12	-	-
30886	15-5/8	8-1/4	8	13-3/8	6-5/8	7-15/16	740	3.20	8	40880 (7)	12	-	-
30806	15-5/8	11-1/8	8	13-3/8	9-7/16	7-15/16	1044	4.52	4	40800 (7)	12	-	-
30826	15-5/8	22-1/2	8	12-15/16	20-1/4	7-15/16	2213	9.58	4	40820 (7)	6	41826 (7)	12
30848	17-7/8	4-1/8	8	15-5/8	2-9/16	7-15/16	382	1.65	8	40840 (7)	12	-	-
30868	17-7/8	6-5/8	8	15-5/8	5	7-15/16	672	2.91	10	40860 (7)	12	-	-
30888	17-7/8	8-1/4	8	15-5/8	6-5/8	7-15/16	851	3.68	8	40880 (7)	12	-	-
30808	17-7/8	11-1/8	8	15-5/8	9-7/16	7-15/16	1200	5.19	4	40800 (7)	12	-	-
30818	17-7/8	16-1/2	8	15-3/16	14-7/16	7-15/16	1897	8.21	4	40818 (7)	6	41818 (7)	6
30828	17-7/8	22-1/2	8	15-3/16	20-1/4	7-15/16	2545	11.02	4	40820 (7)	6	41818 (7)	6
30838	17-7/8	33	8	15-3/16	30-5/8	7-15/16	3817	16.52	4	40838 (7)	6	41818 (7)	6
30844	23-5/8	4-1/8	8	21-3/8	2-9/16	7-15/16	529	2.29	8	40840 (7)	12	-	-
30864	23-5/8	6-5/8	8	21-3/8	5	7-15/16	932	4.03	10	40860 (7)	12	-	-
30884	23-5/8	8-1/4	8	21-3/8	6-5/8	7-15/16	1179	5.10	8	40880 (7)	12	-	-
30804	23-5/8	11-1/8	8	21-3/8	9-7/16	7-15/16	1662	7.19	4	40800 (7)	12	-	-
30814	23-5/8	16-1/2	8	20-15/16	14-7/16	7-15/16	2533	10.97	4	40818 (7)	6	41814 (7)	6
30824	23-5/8	22-1/2	8	20-15/16	20-1/4	7-15/16	3523	15.25	4	40820 (7)	6	41814 (7)	6

One color per carton. Specify Red, Blue, Yellow or Clear. Order in carton quantities. * () = Max. # of divider slots per bin.

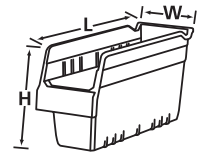

ACCESSORIES

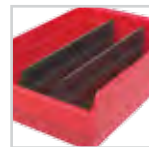

Length Dividers
Available for 7 bin models

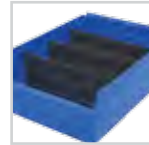

Width Dividers
Available for all sizes



Adhesive Labels
Clearly identify bin contents (See page 13)

Perfect for Vertical Carousel AS/AR



RELATED PRODUCTS

Increase the benefits of your ShelfMax8 Bins with these products



61-63 Wire Shelving Systems



64-67 Steel Shelving Systems



Indicator® Bin

TWO-TONE INVENTORY CONTROL BIN

NEW COLOR

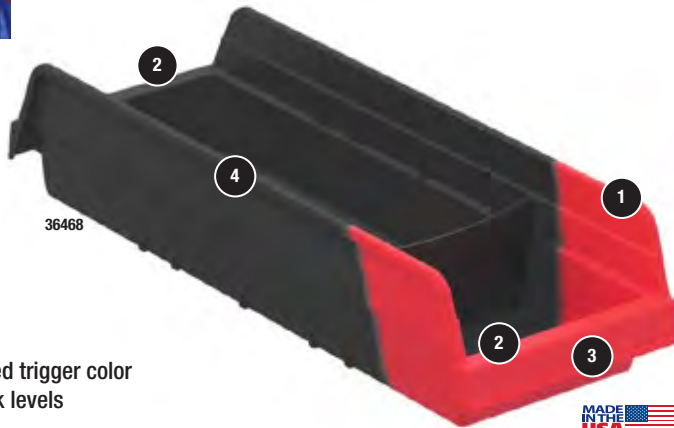

FEATURES

- 1 Bright orange/red trigger color shows low stock levels
- 2 Innovative double-hopper bin can be filled or picked from both sides
- 3 Large label area on both sides of bin
- 4 Rolled ridge provides added strength and durability
- 5 Width dividers (sold separately) used to separate reserve stock

COLORS

Blue/Orange, Black/Red

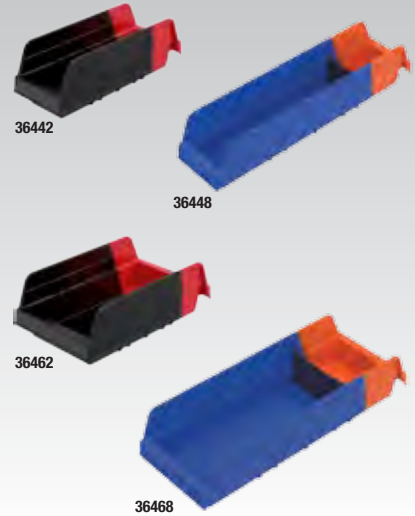

PRODUCT HIGHLIGHTS

- **INVENTORY CONTROL** – Prevents stockouts with visual recognition when supplies need to be replenished
- **EASY TO USE:**
 - STOCK* – using the divider to designate volume for the inventory reserve
 - PICK* – from the blue/black side of the bin until you reach the divider
 - FLIP* – the bin to the orange/red reserve to show inventory levels are low
 - REPLENISH* – the bin and repeat!
- **VALUE** – Low-cost alternative to high-end inventory control systems

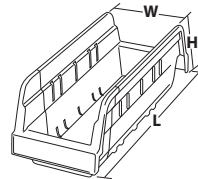

Stock Pick Flip Replenish



Indicator Bins		Outside Dimensions (In.)			Inside Dimensions (In.)			Accessories		
Model No.	Description	L	W	H	L	W	H	Bin Ctn. Qty.	Dividers*	Divider Pkg. Qty.
36442BLUE	Blue/Orange Bin	11-5/8	4-1/4	4	9-7/8	2-7/8	3-7/8	24	40120	24
NEW! 36442BLKRED	Black/Red Bin	11-5/8	4-1/4	4	9-7/8	2-7/8	3-7/8	24	40120	24
36448BLUE	Blue/Orange Bin	17-7/8	4-1/8	4	16-1/8	2-3/4	3-7/8	12	40442	12
NEW! 36448BLKRED	Black/Red Bin	17-7/8	4-1/8	4	16-1/8	2-3/4	3-7/8	12	40442	12
36462BLUE	Blue/Orange Bin	11-5/8	6-3/4	4	9-7/8	5-3/8	3-7/8	12	40130	24
NEW! 36462BLKRED	Black/Red Bin	11-5/8	6-3/4	4	9-7/8	5-3/8	3-7/8	12	40130	24
36468BLUE	Blue/Orange Bin	17-7/8	6-5/8	4	16-1/8	5-1/4	3-7/8	12	40462	12
NEW! 36468BLKRED	Black/Red Bin	17-7/8	6-5/8	4	16-1/8	5-1/4	3-7/8	12	40462	12

*Dividers sold separately.

ACCESSORIES



Width Dividers
Available for all sizes



Adhesive Labels
Adhesive labels are ideal for bin contents identification. (See page 13)

RELATED PRODUCTS

Create the perfect storage solution – mix and match your Indicator Bins with these products

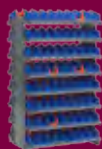

39-41 Pick Rack Systems



61-63 Wire Shelving Systems



64-67 Steel Shelving Systems



AkroDrawers®

HEAVY-DUTY STORAGE DRAWERS

STORAGE BINS -
SHELF STYLE

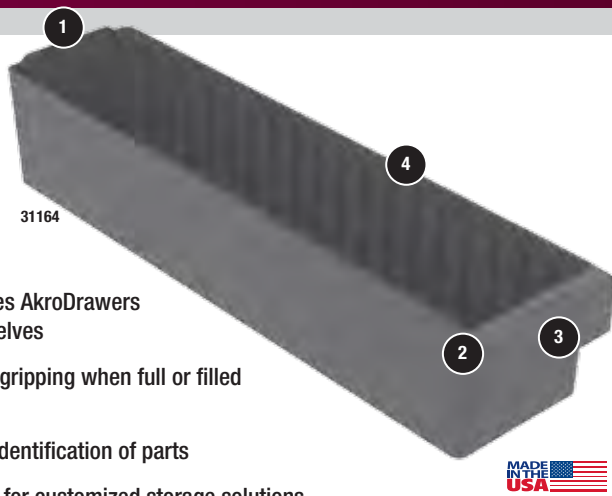

MADE IN THE USA



FEATURES

- 1 Sturdy backstop tab ensures AkroDrawers can hang securely from shelves
- 2 Wide front handle for easy gripping when full or filled with heavy contents
- 3 Large label area for quick identification of parts
- 4 Multiple divider slots allow for customized storage solutions

PRODUCT HIGHLIGHTS

- **PARTS PROTECTION** – AkroDrawers help keep your supplies, tools and parts secure and dust-free
- **FUNCTIONAL** – Drawers can be used with Akro-Mils' Super Modular Cabinets, Stackable Cabinets, Secure Mini-Cabinets, Louvered Carts, Pick Racks and Enclosed Steel Shelving
- **DURABLE** – Color drawers made of high-impact polystyrene; Crystal Clear drawers made of a durable acrylic blend
- **STACKABLE** – AkroDrawers can be stacked to optimize space
- **VARIETY** – Available in 9 sizes and 5 colors: Red, Yellow, Blue, Crystal Clear, Gray

AkroDrawers®

AkroDrawers Model No.	Outside Dimensions (In.)			Inside Dimensions (In.)			Capacity/Qty.		Dividers*	Pkg. Qty
	L	W	H	L	W	H	Weight Capacity	Ctn. Qty.		
31142	11-5/8	3-3/4	4-5/8	10-1/4	3-1/16	4-7/16	15 lbs.	6	41440 (8)	6
31148	17-5/8	3-3/4	4-5/8	16-1/4	3-1/16	4-7/16	20 lbs.	6	41440 (13)	6
31162	11-5/8	5-9/16	4-5/8	10-1/4	4-7/8	4-7/16	20 lbs.	6	41460 (8)	6
31168	17-5/8	5-9/16	4-5/8	16-1/4	4-7/8	4-7/16	25 lbs.	6	41460 (13)	6
31164	23-7/8	5-9/16	4-5/8	22-1/2	4-7/8	4-7/16	25 lbs.	6	41460 (18)	6
31182	11-5/8	8-3/8	4-5/8	10-1/4	7-5/8	4-7/16	20 lbs.	4	41480 (8)	6
31188	17-5/8	8-3/8	4-5/8	16-1/4	7-5/8	4-7/16	25 lbs.	4	41480 (13)	6
31112	11-5/8	11-1/8	4-5/8	10-1/4	10-7/16	4-7/16	25 lbs.	4	41410 (8)	8
31118	17-5/8	11-1/8	4-5/8	16-1/4	10-7/16	4-7/16	25 lbs.	4	41410 (13)	8

Specify drawer color when ordering: Red, Blue, Yellow, Gray or Crystal Clear. (*) = Max. # of divider slots per bin.

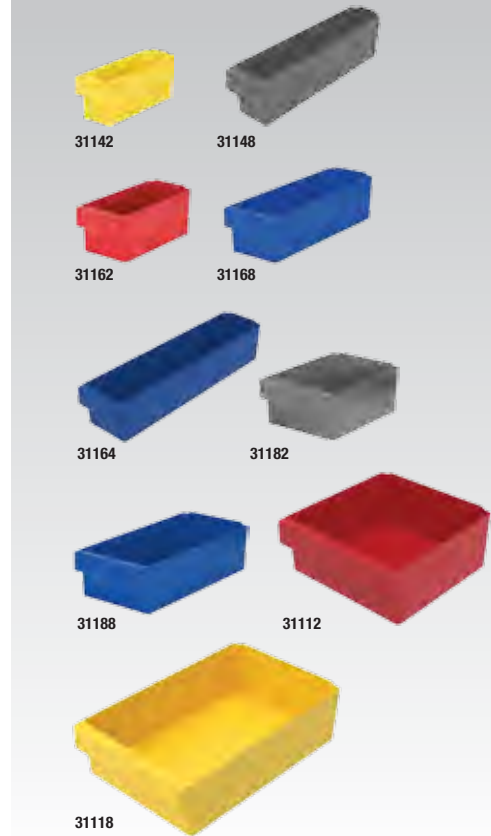

COLORS

Red, Yellow, Blue, Crystal Clear, Gray



AVAILABLE IN
CLEAR
CRYSTAL



31168

ACCESSORIES



Width Dividers
Available for all sizes



Adhesive Labels
Adhesive labels are ideal for content identification and form a permanent bond with bins. (See page 13)

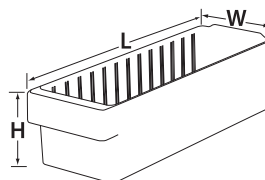

RELATED PRODUCTS

Create the perfect storage solution — mix and match your AkroDrawers with these products





System Bins™ : Economy Bins

NESTING / STACKING BINS

System Bins™

SINGLE-PIECE,
6-COMPARTMENT
STORAGE UNIT



30318



PRODUCT HIGHLIGHTS

- **SINGLE-PIECE** – Configured six-across in a single unit, 33" wide by 5" high; bins are sized to fit on 36" wide steel and wire shelving
- **VALUE** – A cost-effective alternative to flimsy, cardboard boxes
- **DURABLE** – Sturdy interior double-wall construction. One-piece, injection-molded
- **STACKABLE** – Can be safely stacked using a 3/8" wood dowel rod (not included)
- **NESTABLE** – Bins nest when empty to conserve space
- **VARIETY** – Available in 12" or 18" depths. Colors: Red, Yellow, Blue

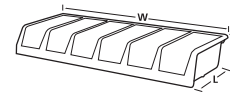

COLORS
Red, Yellow, Blue



System Bins™

System Bins		Dimensions (In.)			Bin Compartment Dimensions (In.)**			Ctn. Qty.
Model No.	Description	L	W	H	L	W	H	
30312	12" System Bin	12	33	5	10-3/8	3-5/8	4-15/16	5
30318	18" System Bin	18	33	5	16-3/8	3-5/8	4-15/16	5
40312*	System Bin Divider (Black only)	5/32	4-7/8	4-7/8	-	-	-	6 pk.

One color per carton: Specify Red, Blue or Yellow. Order in carton quantities. *One divider per compartment, six per unit. **Bottom inside dimension per compartment.

Economy Bins

NESTING & STACKING SHELF BIN



30716

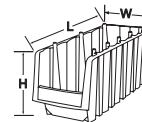

COLOR
Black



Economy Bins	Outside Dimensions (In.)			Inside Dimensions (In.)			Ctn. Qty.
Model No.	L	W	H	L	W	H	
30796BLACK	8-7/8	6-5/8	5	6-3/25	4	4-9/10	10
30716BLACK	11-7/8	6-5/8	5	9-3/25	4	4-9/10	10
30776BLACK	17-7/8	6-5/8	7	14-8/9	3-4/5	6-9/10	10
30718BLACK	11-7/8	8-3/8	5	9	5-3/4	4-9/10	8
30778BLACK	17-7/8	8-3/8	7	14-4/5	5-1/2	6-9/10	8

Order in carton quantities.



- **VERSATILE** – Economy Bins make full use of shelf space on 12" or 18" deep shelving and stack to fill space between shelves
- **DURABLE** – Industrial-grade polymer construction
- **EXCLUSIVE** – The only small parts bin that can nest and stack
- **EFFICIENT** – Generous bin opening allows easy access to items

Attached Lid Containers : KeepBox™

DISTRIBUTION CONTAINERS/STORAGE BOXES



Attached Lid Containers

INDUSTRIAL-GRADE



FEATURES

- 1 Textured bottoms provide a sure grip on conveyor belts
- 2 Strong molded-in handle grips are ergonomically designed for easy lifting and carrying
- 3 Padlock eye on both ends accommodate security ties
- 4 Reinforced hinge pins for years of smooth lid operation

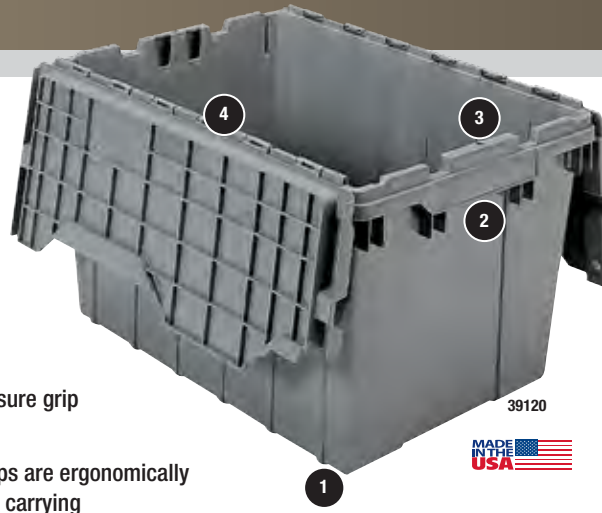

COLORS

Red, Blue, Green, Gray



PRODUCT HIGHLIGHTS

- **FUNCTIONAL** – Reusable shipping, distribution, order picking and storage containers
- **SECURE** – Attached lids snap securely closed to protect contents from dust and damage
- **INTERWORKING** – Containers interwork for easy pallet loading
- **STACKABLE and NESTABLE** – Containers stack on closed lids and nest in open lids
- **VARIETY** – 6 sizes and 4 colors. See the chart below for color options per model
- **CUSTOMIZE** – Custom colors and hot stamping available

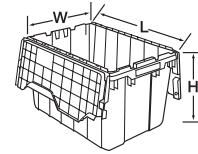

Attached Lid Containers (ALCs)		Outside Dimensions (In.)			Inside Dimensions Top (In.)			Inside Dimensions Bottom (In.)		Capacity/Qty.				Accessories	
Model No.	Available Colors	L	W	H	L	W	H	L	W	Cu. Ft.	Gal.	Lbs.	Container Ctn. Qty.	Stack Cap./Qty. Stacked	Steel Dollies
39085	Blue, Gray	21-1/2	15	9	19-3/4	14-1/2	8-5/8	18-7/16	13-1/4	1.12	8.5	35	6	35 lbs./5	RU843HR1420
39120	Blue, Green, Red, Gray	21-1/2	15	12-1/2	19-3/4	14-1/2	12	18-7/16	13-1/4	1.62	12	65	6	65 lbs./5	RU843HR1420
39160	Gray	27	17	12-1/2	25	15-1/2	11	23-1/2	14	2.25	16.83	100	1	100 lbs./4	–
39170	Blue, Gray	21-1/2	15	17	19-3/4	14-1/2	16-7/8	18-7/16	13-1/4	2.28	17	100	3	100 lbs./3	RU843HR1420
39175	Gray	24	19-1/2	12-1/2	22	18	11	20-1/2	16-1/2	2.3	17.20	80	1	80 lbs./5	–
39280	Gray	28	21	15-1/2	26	19	14	25	18	3.82	28.57	100	1	100 lbs./4	–

Order in carton quantities. Specify color when ordering.

KeepBox™

LIGHT-DUTY STORAGE



PRODUCT HIGHLIGHTS

- **FUNCTIONAL** – Secure, dust-free storage
- **NESTABLE** – Containers nest when empty
- **CLEAR** – Sides keep contents visible
- **REINFORCED** – Hinge pins for years of smooth lid operation



COLOR
Blue/Clear



KeepBox		Outside Dimensions (In.)			Inside Dimensions Top (In.)			Inside Dimensions Bottom (In.)		Capacity/Qty.				
Model No.	Description	L	W	H	L	W	H	L	W	Cu. Ft.	Gal.	Lbs.	Ctn. Qty.	Stack Cap./Qty. Stacked
66486CLDBL	12 gal. KeepBox	21-1/2	15	12-1/2	19-3/4	14-1/2	12	17-7/8	12-3/4	1.6	12	25	6	5

Order in carton quantities.



Nest & Stack Totes

EXTREMELY DURABLE INDUSTRIAL-GRADE TOTES



35200



FEATURES

- 1 Smooth surfaces are easy to clean
- 2 Comfortable grip makes handling easy
- 3 Ribs under the lip prevent jamming when nested
- 4 Textured bottoms provide a no-slip grip on conveyor belts
- 5 Wide stacking ledge allows totes to securely stack without lids in place
- 6 Lids have tie holes for extra security

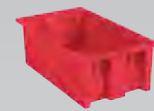

35180

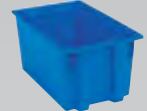

35185

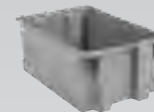

35190



35195



35200

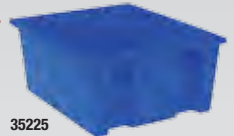

35225



35230



35240



35300

COLORS

Red, Blue, Gray



PRODUCT HIGHLIGHTS

- **FUNCTIONAL** – Ideal for shipping, transfer and storage applications
- **STACKBLE** – NSTs stack with or without lids for storage and shipping
- **NESTABLE** – Totes nest when empty
- **DURABLE** – Strong, industrial-grade polymer will not rust, corrode or bend out of shape even when fully loaded
- **COST-EFFECTIVE** – Long service life resulting in lower replacement costs
- **FDA-SANCTIONED** – NSTs are manufactured from FDA-sanctioned materials
- **VARIETY** – Available in 9 sizes and 3 colors: Red, Blue, Gray
- **CUSTOMIZE** – Custom colors and hot stamping available

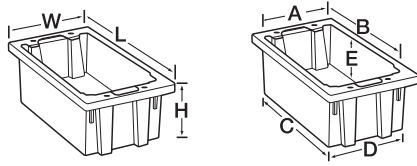

Nest & Stack Totes (NSTs)	Outside Dimensions (In.)			Inside Dimensions (In.)					Capacity/Qty.				Accessories			
	Model No.	L	W	H	A	B	C	D	E	Cu. Ft.	Gal	Lbs.	Tote Ctn. Qty.	Stacking Height	Lid Model	Lid Ctn. Qty.
35180	18	11	6	10	16	15-1/4	9-3/8	5-7/8	0.5	3.7	45	6	6	35181	6	-
35185	18	11	9	10	16	15-1/8	9-1/8	8-7/8	0.76	5.69	60	6	6	35181	6	-
35190	19-1/2	15-1/2	10	14-1/2	17	16	13-1/4	9-7/8	1.2	9	65	6	6	35191	6	-
35195	19-1/2	15-1/2	13	14-1/2	17	15-7/8	13-3/8	12-7/8	1.7	12.93	85	6	6	35191	6	-
35200	19-1/2	13-1/2	8	12-3/8	17-1/8	16-3/8	11-1/2	7-7/8	0.8	6.1	55	6	6	35201	6	-
35225	23-1/2	19-1/2	10	18-1/4	20-7/8	19-3/8	16-7/8	9-7/8	2	14.98	70	3	6	35231	3	RU843HR1822
35230	23-1/2	19-1/2	13	18-1/8	20-7/8	19-1/2	16-7/8	12-7/8	2.6	19.4	90	3	6	35231	3	RU843HR1822
35240	23-1/2	15-1/2	12	14-1/4	20-7/8	19-5/8	13	11-7/8	1.7	12.9	75	3	6	35241	3	RU843HR1422
35300	29-1/2	19-1/2	15	18-1/4	26-5/8	25-1/8	16-5/8	14-7/8	3.7	27.4	100	3	6	35301	3	RU843HR1828

One color per carton. Specify color: Red, Blue or Gray. Order in carton quantities.

Label Holders		
Model No.	Pkg. Qty.	Label Size (In.)
35010	6	3-3/4 x 5
35011	6	3 x 5

ACCESSORIES



Lids
Protect contents from dust and damage, include tie holes

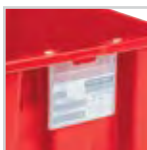

Clear Plastic Label Holders
Accommodate labels up to 3 3/4" x 5"



RELATED PRODUCTS

Create the perfect storage solution. Combine Nest & Stack Totes with



61-63 Wire Shelving Systems



69 Dollies



81 ProCart



Akro-Grid

DIVIDABLE GRID CONTAINERS

NEW SIZES!

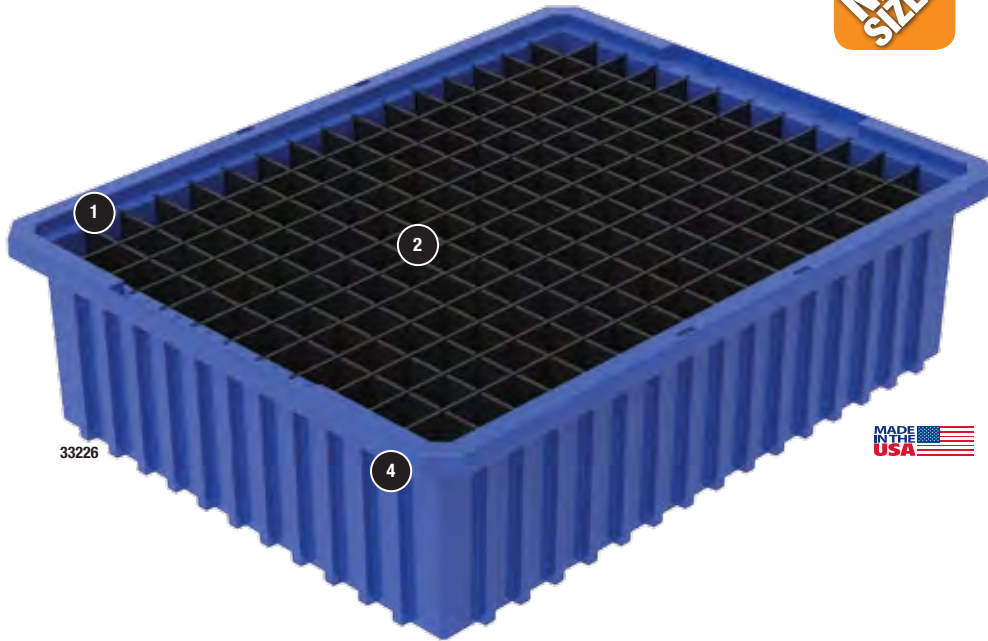

MADE IN THE USA

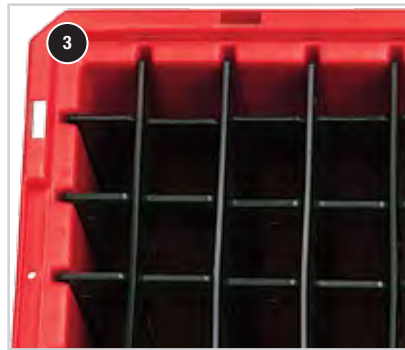

FEATURES

- 1 Divider slots allow you to create hundreds of compartment sizes
- 2 Dividers (sold separately) allow subdivision of the containers to a 1 1/8" square compartment size
- 3 Molded-in letter/number system for easy parts tracking
- 4 Strong stacking rims and external ribbing provide added strength

PRODUCT HIGHLIGHTS

- **FUNCTIONAL** – Compatible with most racks, shelving and automated storage retrieval systems
- **DURABLE** – Injection-molded from industrial-grade polymers. Resists most solvents and chemicals
- **COST-EFFECTIVE** – Longer service life resulting in lower replacement costs
- **VARIETY** – Available in 9 sizes and 4 colors: Red, Blue, Clear, Gray
- **CUSTOMIZE** – Custom colors and hot stamping available



COLORS

Red, Blue, Clear, Gray



AVAILABLE IN CLEAR



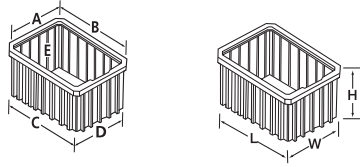

Akro-Grids	Outside Dimensions (In.)			Inside Dimensions (In.)					Capacity/Qty.				Accessories				
	Model No.	L	W	H	A	B	C	D	E	Cu. Ft.	Gal	Lbs.	Bin Ctn. Qty.	Long Divider*	Short Divider*	Divider Pkg. Qty.	Max. No. of Compartments
NEW! 33103	10-7/8	8-1/4	3-1/2	6-9/16	9-3/16	9-1/8	6-7/16	3-3/8	0.12	0.92	25	20	42103 (5)	41103 (7)	6	48	-
33105	10-7/8	8-1/4	5	6-11/16	9-5/16	9-1/8	6-1/2	4-5/8	.16	1.2	25	20	42105 (5)	41105 (7)	6	48	-
NEW! 33162	16-1/2	10-7/8	2-1/2	9-3/16	14-13/16	14-3/4	9-1/8	2-3/8	0.20	1.5	20	12	42162 (7)	41162 (7)	6	96	-
33164	16-1/2	10-7/8	4	9-3/8	14-15/16	14-13/16	9-3/16	3-7/8	.29	2.2	20	12	42164 (7)	41164 (11)	6	96	-
NEW! 33165	16-1/2	10-7/8	5	9-3/16	14-13/16	14-5/8	9	4-7/8	0.39	2.9	35	12	42165 (7)	41165 (11)	6	96	-
33166	16-1/2	10-7/8	6	9-5/16	14-7/8	14-3/4	9-1/8	5-9/16	.44	3.3	35	8	42166 (7)	41166 (11)	6	96	-
33168	16-1/2	10-7/8	8	9-5/16	14-15/16	14-5/8	9-1/16	7-9/16	.59	4.4	40	6	42168 (7)	41168 (11)	6	96	-
33220	22-3/8	17-3/8	10	15-1/4	20-1/8	19-7/8	14-7/8	9-7/8	1.66	12.4	50	2	42220 (11)	41220 (15)	6	192	RU843HR1621
NEW! 33222	22-1/2	17-1/2	12	15-5/16	20-5/16	19-15/16	14-15/16	11-13/16	2.10	15.9	60	3	42222 (11)	41222 (15)	6	192	RU843HR1621
33223	22-1/2	17-3/8	3	15-7/16	20-1/2	20-7/16	15-3/8	2-1/2	.47	3.5	30	6	42223 (11)	41223 (15)	6	192	RU843HR1621
33224	22-3/8	17-3/8	4	15-1/16	20-1/16	20	15	3-7/8	.61	4.6	30	6	42224 (11)	41224 (15)	6	192	RU843HR1621
33226	22-3/8	17-3/8	6	15-1/8	20-1/8	19-7/8	14-7/8	5-7/8	.96	7.2	40	4	42226 (11)	41226 (15)	6	192	RU843HR1621
33228	22-3/8	17-3/8	8	15-1/8	20-1/8	19-7/8	14-7/8	7-7/16	1.30	9.7	50	3	42228 (11)	41228 (15)	6	192	RU843HR1621

One color per carton. Specify Red, Blue, Gray or Clear. Order in carton quantities. *() = max # of dividers.

Clear Snap-On Lids	Outside Dimensions (In.)			Fits Grid No.	Ctn. Qty.
Model No.	L	W	H		
33011	11-1/2	8-11/16	15/16	33103, 33105	10
33061	17-3/16	11-5/16	15/16	33162, 33164, 33165, 33166, 33168	4
33023	23-5/16	18-1/16	15/16	33220, 33222, 33223, 33224, 33226, 33228	3

Label Holders		
Model No.	Fits Grid No.	Pkg. Qty.
35010	Fits all except 33164, 33223, 33224	6
35011	33164, 33224	6

Adhesive Label		
Model No.	Fits Grid No.	Pkg. Qty.
29203	33223	10 sheets (120 total)

ACCESSORIES



Dividers
Allow subdivision of the containers down to 1 1/8" square compartments



Clear Plastic Label Holders
Snap securely on any side of the container (except 33223)



Clear Snap-On Lids
Durable injection-molded lids keep contents clean yet visible

RELATED PRODUCTS

Create the perfect storage solution, pair your Akro-Grids with



61-63 Wire Shelving Systems



69 Dollies



81 ProCart



Multi-Load Tote

DESIGNED FOR MINI-LOAD AUTOMATED STORAGE AND RETRIEVAL SYSTEMS (AS/RS)



FEATURES

- 1 Reinforced bottom, ribbed side walls and a reinforced rim for added strength and stability
- 2 Straight walls for efficient cubing on pallets and AS/RS systems
- 3 Designated 2" x 4" label areas on length side of tote provide consistent scanning and allow for easy tote orientation at picking stations
- 4 The unique sidewall clip design allows cups and dividers to attach quickly and securely to the tote
- 5 Solid reinforced bottom has large flat areas for a smooth and quiet ride on conveyors

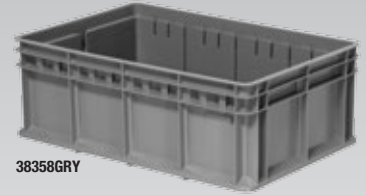

38358GRY



38004



38008



48300



48301

COLOR
Gray



Dividers cross link to create 4 to 8 sturdy compartments.

PRODUCT HIGHLIGHTS

- **FUNCTIONAL** – Versatile tote for general storage and logistics applications
- **DURABLE** – Injection-molded from industrial-grade polymers; patented design allows dividers and cups to remain stable and secure in the most demanding applications

Multi-Load Totes & Cups		Outside Dimensions (mm)			Outside Dimensions (In.)			Capacity/Qty.		
Model No.	Description	L	W	H	L	W	H	Cu. Ft.	Lbs.	Ctn. Qty.
38358GRY	Multi-Load Tote - Gray	600	400	220	23-5/8	15-3/4	8-21/32	1.50	80	4
38008YEL	1/8 Cup - Yellow	184	136	210	7-1/4	5-3/8	8-9/32	0.14	–	12
38004RED	1/4 Cup - Red	369	136	210	15-1/2	5-3/8	8-9/32	0.29	–	6
48300	Length Divider - Black	–	–	–	–	–	–	–	–	1
48301	Width Divider - Black	–	–	–	–	–	–	–	–	3

Order in carton quantities.

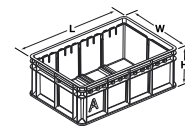

ACCESSORIES



Length Dividers
Have crosslink tabs that can be removed when used with width dividers



Width Dividers
Have crosslink tabs that can be removed when used with length dividers



1/4 Bin Cup
Create up to 4 secure compartments



1/8 Bin Cup
Create up to 8 secure compartments



Straight Wall Containers

INDUSTRIAL REUSABLE CONTAINERS



37208



37678



37682



37616

COLORS

Red, Gray



FEATURES

- 1 1" wall thickness for secure stacking
- 2 Strong 1" wide stacking rims and external ribbing provide added strength
- 3 Straight walls provide efficient cubing in trucks and on pallets
- 4 Open .72 x .90 mesh pattern allows high visibility and good airflow
- 5 Large handles on 4 sides for easy and comfortable grip

PRODUCT HIGHLIGHTS

- **FUNCTIONAL** – Reusable shipping, storage and work-in-process containers
- **SOLID** – Smooth inner walls for easy, sanitary cleaning
- **MESH** – Allow air ventilation and drainage
- **DURABLE** – Injection-molded from industrial-grade polymers
- **VARIETY** – Available in 12 configurations, 4 sizes and 2 colors: Red, Gray
- **CUSTOMIZE** – Custom colors and hot stamping available

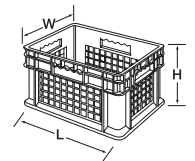

Straight Wall Containers (SWCs)			Outside Dimensions (In.)			Inside Dimensions Bottom (In.)			Capacity/Qty.			Stacked Capacity/Qty.		Accessories
Model No. Mesh Side & Base	Model No. Mesh Side/Solid Base	Model No. Solid Side & Base	L	W	H	L	W	H	Cu. Ft.	Gal.	Container Ctn. Qty.	Solid Bottom	Mesh Bottom	Steel Dollies
37208	37278	37288	15-3/4	11-3/4	8-1/4	14	10	8	0.89	5.12	12	83 lbs./6	30 lbs./6	–
37608	37678	37688	23-3/4	15-3/4	8-1/4	22	14	8	1.78	11.19	4	83 lbs./6	45 lbs./6	RU843HR1624
37612	37672	37682	23-3/4	15-3/4	12-1/4	22	14	12	2.67	8.32	3	125 lbs./5	45 lbs./5	RU843HR1624
37616	37676	37686	23-3/4	15-3/4	16-1/8	22	14	16	3.55	11.07	2	150 lbs./4	45 lbs./4	RU843HR1624

Order in carton quantities. Specify color when ordering.

RELATED PRODUCTS

Add more productivity to your Straight Wall Containers with



61-63 Wire Shelving Systems



69 Dollies

Akro-Tubs

IDEAL FOR FOOD PROCESSING, INDUSTRIAL ACTIVITIES



FEATURES

- 1 Rolled top rim forms comfortable handles
- 2 Extra-thick walls for superior strength
- 3 Rounded corner design adds strength to stress points
- 4 Ribs prevent jamming when nested



MADE IN THE USA

PRODUCT HIGHLIGHTS

- **FDA-SANCTIONED** – Tub manufactured from FDA-sanctioned materials
- **SMOOTH SURFACE** – Easy to clean
- **NESTABLE** – Nests when empty to conserve space

Akro-Tub Model No.	Dimensions (In.)					Capacity/Qty.			
	L	W	H	A	B	Cu. Ft.	Gal.	Lbs.	Ctn. Qty.
34240	19	24-1/2	9-1/2	20-1/2	15-1/2	1.95	14.6	75	6
RA6TR4MR	24	24	73	-	-	-	-	600	-

Order in carton quantities.

COLOR
Gray

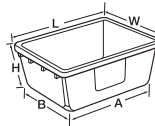

AKRO-TUB RACK

Model No. RA6TR4MR
Holds 6 Akro-Tubs for up to 600 lb. total capacity. Welded steel frame with 12-gauge base and bolted-on casters (Akro-Tubs sold separately). Casters: 4" x 2" Mold-On Rubber: 2 Rigid, 2 Swivel



UP TO 600 LBS.

Cross-Stack Akro-Tubs



FEATURES

- 1 Stacking grooves allow stable 90° stacks
- 2 Molded-in handles for easy lifting
- 3 Extra-thick walls and reinforcing ribs provide superior strength
- 4 Lid available for 34305



34305 with 34005 lid

MADE IN THE USA

PRODUCT HIGHLIGHTS

- **FDA-SANCTIONED** – Tub manufactured from FDA-sanctioned materials
- **FUNCTIONAL** – Industrial-grade tub is compatible with standard 36" shelving and conveyor systems
- **NESTABLE** – Nesting when empty conserves storage space
- **STACKABLE** – Cross-stacking
- **SMOOTH SURFACE** – Easy to clean

NEW!

Cross-Stack Akro-Tub Model No.	Outside Dimensions (In.)					Accessories Lid	Capacity/Qty.		
	L	W	H	A	B		Cu. Ft.	Gal.	Ctn. Qty.
34301	17-1/4	11	8	13-1/4	7-3/4	-	0.52	3.85	6
34302	17-1/4	11	12	12-5/8	7	-	0.74	5.51	6
34303	23-3/4	17-1/4	8	19-3/4	14	-	1.31	9.81	6
34304	23-3/4	17-1/4	12	19	13-1/4	-	1.92	14.38	6
34305*	25	16	8-1/2	20-3/8	11-1/2	34005*	1.25	9.75	6
RACR5MR	53	29	62	-	-	-	-	1000	-

One color per carton. *Available in Blue, Gray or Natural. Specify color. Order in carton quantities.

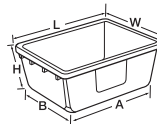

COLORS
Gray, Blue, Natural

DOUBLE-SIDED CROSS-STACK AKRO-TUB RACK

Model No. RACR5MR
Holds (32) 34301 or (16) 34303 Cross-Stack Akro-Tubs (sold separately). Casters: 5" x 2" Mold-On Rubber: 2 Rigid, 2 Swivel



UP TO 1000 LBS.

Easy Flow Gravity Hopper

HOPPER SYSTEM WITH COMPACT VERTICAL DESIGN

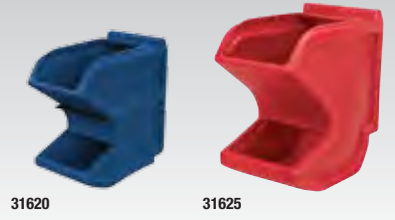

COLORS
Red, Blue

GRAVITY HOPPER FLOOR RACK

Model No. 31625RACK
Holds 9 large or 12 small hoppers per side. 13-gauge steel powder-coated rack has a 900-lb. weight capacity. Hoppers sold separately



FEATURES

- 1 Large angled top opening for easy filling
- 2 Generous picking area provides easy access to loaded product
- 3 First-In-First-Out (FIFO) sliding divider shelf for time-sensitive inventory (for 31620 hopper only)

PRODUCT HIGHLIGHTS

- **FUNCTIONAL** – Allows for proper lot rotation. Great for fasteners, assembly areas, Kanban, inventory stock, merchandise and work cells
- **CAPACITY** – 31620: 50 lbs.; 31625: 75 lbs.
- **DURABLE** – Rotational-molded for strength and durability
- **VARIETY** – Available in 2 sizes and 2 colors. 31625 available in Red and Blue; 31620 available in Blue only

Easy Flow Gravity Hopper		Dimensions (In.)				Capacity/Qty.			
Model No.	Description	L	W	H	D	Cu. In.	Gal.	Lbs.	Ctn. Qty.
31620 [‡]	Small Easy Flow Gravity Hopper	16	8-1/4	16	10	1400	6	50	1
31625	Large Easy Flow Gravity Hopper	18	10-3/4	19-1/2	8	2400	10.39	75	1

When ordering 31625 specify color Red or Blue. ‡ Sliding divider shelf with 31620 hopper only.

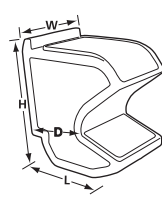

Accessories		
Model No.	Description	Wt. Cap.
31625RACK	Easy Flow Gravity Hopper Rack 36" x 36" x 69"	900 lbs.
30600DOLLY	Easy Flow Gravity Hopper Dolly with 4" x 1-1/2" Polyolefin Casters	900 lbs.
30600BRACKET	Easy Flow Gravity Hopper Bracket	75 lbs.

ACCESSORIES



30600DOLLY
Optional dolly to mobilize 31625RACK has 4 swivel casters (2 with brakes)



30600BRACKET
Optional bracket to hang hoppers from louvered panels or rail racks





Louvered Hanging Systems : AkroShelf™ : Louvered Panel Hooks

CUSTOMIZABLE VERTICAL STORAGE FOR HANGING BINS

UP TO
2000
LBS.

HOW TO CHOOSE: Louvers vs. Rails

Louvers: Steel panels with rows of punched louvers. More storage capacity, greater selection of styles. Panels can be attached to the wall, freeing floor space. Rivet racks come with the panels already riveted to the frame.

Rails: (Page 38) Constructed of individual steel rails that span between uprights. Weigh less than louvered panels, more economical, small footprint, easy to remove bins from rails.



FEATURES

- 1 Louvered Panels securely support AkroBins® and InSight® Bins (sold separately, see Pgs. 4, 8)
- 2 Heavy-duty 16-gauge, cold-rolled steel for strength and durability
- 3 Attractive, durable powder-coated finish
- 4 Save installation time with Rivet Racks! Models 30661, 30638 and 30676 are full louvered panels mounted to a heavy-duty frame



PRODUCT HIGHLIGHTS

- **EFFICIENT** – Wall-mounted units keep items out of the way, off the floor and off the work table
- **FLOOR RACKS** – Can be placed near work areas to improve productivity
- **SINGLE-SIDED RACKS** – Can be placed against a wall to save floor space
- **DOUBLE-SIDED RACKS** – Expand storage options
- **MOBILE KIT** – Available to mobilize two-sided racks
- **FLEXIBILITY** – **NEW!** Louvered Panel Hooks for your Akro-Mils louvered panels and racks are great for hanging tools, rolls of tape, hoses and tubing, sanding belts and more

WALL PANELS

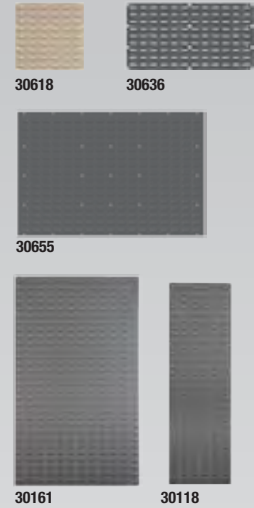

HEAVY-DUTY FLOOR RACKS

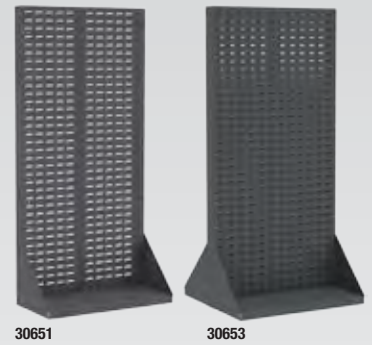

RIVET FLOOR RACKS



COLORS
Gray, Beige





AkroBin Louvered Hanging Systems			Dimensions (In.)				AkroBin Quantity to Fit Louvered Hanging System – AkroBins Model No.														
Model No.	Description	Ctn. Qty	L	W	H	Rack Wt. Cap.(lbs.)	30210	30220	30224	30230	30234	30235	30237	30239	30240	30250	30255	30260	30265	30270	30320
30618*	Louvered Wall Panel	4	18	5/16	19	160	16	16	12	9	9	3	6	4	4	2	3	1	2	1	-
30636*	Louvered Wall Panel	4	35-3/4	5/16	19	160	32	32	24	18	18	9	15	8	8	4	6	3	4	2	3
	2 Louvered Wall Panels		35-3/4	5/16	37	-	72	72	36	36	36	18	30	16	16	8	12	6	8	4	5
	3 Louvered Wall Panels		35-3/4	5/16	55	-	104	104	54	54	54	27	45	28	28	14	18	9	12	6	8
	4 Louvered Wall Panels		35-3/4	5/16	73	-	144	144	72	72	72	36	60	36	36	18	24	12	16	8	11
30655	Louvered Wall Panel	1	52	5/16	34-1/8	750	96	96	60	45	45	20	40	24	24	12	15	8	18	6	5
30161*	Louvered Wall Panel	1	36	5/16	61	1000	120	120	80	60	60	30	50	28	28	14	20	15	24	10	10
30118*	Louvered Wall Panel	1	18	5/16	61	500	48	48	36	30	30	14	20	12	12	6	9	5	12	5	-
30651	Heavy-Duty Single-Sided Floor Rack	1	35-3/4	17	75-1/8	1000	144	144	98	72	72	36	60	36	36	18	24	18	28	12	11
30653	Heavy-Duty Double-Sided Floor Rack	1	35-3/4	32	75-1/8	2000	288	288	192	144	144	72	120	72	72	36	48	36	56	24	-
30638	Single-Sided Rivet Floor Rack	1	18	13-1/2	66-3/8	250	48	48	36	30	30	14	20	12	12	6	9	5	12	5	-
30658	Double-Sided Rivet Floor Rack	1	18	25	66-3/8	500	96	96	72	60	60	28	40	24	24	12	18	10	24	10	-
30661*	Single-Sided Rivet Floor Rack	1	36-3/16	13-1/2	66-3/8	500	120	120	80	60	60	30	50	28	28	14	20	15	24	10	10
30676*	Double-Sided Rivet Floor Rack	1	36-3/16	25	66-3/8	1000	240	240	144	108	108	56	100	48	48	24	36	30	48	20	20
30653DOLLY	Mobile Kit for 30653	1	-	-	-	500	-	-	-	-	-	-	-	-	-	-	-	-	-	-	-
LVDMOBILE	Mobile Kit for 30676	1	-	-	-	1500	-	-	-	-	-	-	-	-	-	-	-	-	-	-	-

*Also available in Beige.

NEW!



30636BEIGE with 305A3

InSight Louvered Panel Systems		
Model No.	Description	Bin Qty.
30636BEIGE A1	35-3/4" x 19" Louvered Wall Panel with 305A1	32
30636BEIGE A3	35-3/4" x 19" Louvered Wall Panel with 305A3	32

InSight Louvered Panel Systems		
Model No.	Description	Bin Qty.
30636BEIGE A5	35-3/4" x 19" Louvered Wall Panel with 305A5	32
30636BEIGE B1	35-3/4" x 19" Louvered Wall Panel with 305B1	18

Louvered Panel Hooks

PEGHOOKS FOR LOUVERED PANELS

NEW!



Louvered Panel Hooks		Capacity/Qty.	
Model No.	Description	Wt. Cap. (lbs.)	Pkg. Qty.
LPP6SP	Straight Post - Louvered Panel Peghook - 6" Long	10	6
LPP6WL	Wide Loop - Louvered Panel Peghook - 6" Long	20	6
LPP6NL	Narrow Loop - Louvered Panel Peghook - 6" Long	20	6
LPP3SP	Straight Post - Louvered Panel Peghook - 3" Long	10	6
LPP3WL	Wide Loop - Louvered Panel Peghook - 3" Long	20	6
LPP3NL	Narrow Loop - Louvered Panel Peghook - 3" Long	20	6

AkroShelf™

ADD SHELVES TO LOUVERED PANELS

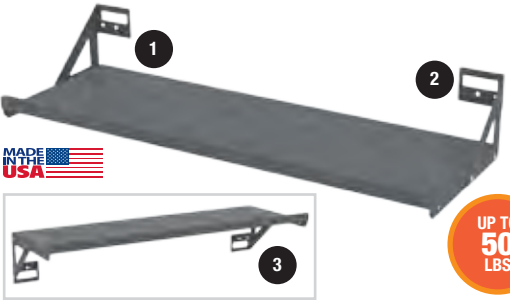

MADE IN THE USA

UP TO 50 LBS.

VIDEO ONLINE

FEATURES

- 1 Slides down securely onto louvered panels; can be quickly removed
- 2 "Bracket Up" option creates a bottom shelf
- 3 "Bracket Down" option creates a top shelf

COLOR Gray



AkroShelf		Shelf Dimensions (In.)			Capacity (Lbs.)	Ctn. Qty.
Model No.	Description	W	L	H		
30635GY	AkroShelf	12-3/4	35-5/8	6-7/16	50	4
30635AGY	AkroShelf	12-3/4	35-5/8	6-7/16	50	1

Caution: Not to be used as a step.

Low Profile Louvered Floor Racks

CUSTOMIZABLE COMPACT STORAGE FOR HANGING BINS



UP TO
1250
LBS.



FEATURES

- 1 Heavy-duty 16-gauge, cold-rolled steel for strength and durability
- 2 Optional shelf adds additional workspace
- 3 Attractive, durable powder-coated finish



30650GY



30656GY



30606GY



30607GY



30606DOLLY shown with 30606GY

COLOR
Gray



Low Profile Floor Rack – Single-Sided		Rack Dimensions (In.)			Bin Dimensions (In.)		Wt. Capacity (Lbs.)				
Model No.	Description	W	H	D	Bin Model No.	L	W	H	Bin Qty.	Panel/Top	Colors
30650GY	Low Profile Floor Rack	52-5/8	40	13-1/2	–	–	–	–	–	500/250	–
30650GY240	Low Profile Floor Rack	52-5/8	40	13-1/2	30240	14-3/4	8-1/4	7	24	500/250	B, R, Y, SC
30650GY250	Low Profile Floor Rack	52-5/8	40	13-1/2	30250	14-3/4	16-1/2	7	12	500/250	B, R, Y, SC
30650GYASST	Low Profile Floor Rack	52-5/8	40	13-1/2	30240 / 30250	See Above			12 / 6	500/250	B, R, Y, SC
30656GY	Low Profile Floor Rack no Shelf	52-5/8	39-7/8	13-1/2	–	–	–	–	–	500	B, R, Y, SC
30656GY240	Low Profile Floor Rack no Shelf	52-5/8	39-7/8	13-1/2	30240	14-3/4	8-1/4	7	24	500	B, R, Y, SC
30656GY250	Low Profile Floor Rack no Shelf	52-5/8	39-7/8	13-1/2	30250	14-3/4	16-1/2	7	12	500	B, R, Y, SC
30656GYASST	Low Profile Floor Rack no Shelf	52-5/8	39-7/8	13-1/2	30240 / 30250	See Above			12 / 6	500	B, R, Y, SC

Specify color of bins when ordering. B=Blue, R=Red, Y=Yellow, SC=Clear.

Low Profile Floor Rack – Double-Sided		Rack Dimensions (In.)			Bin Dimensions (In.)		Wt. Capacity (Lbs.)				
Model No.	Description	W	H	D	Bin Model No.	L	W	H	Bin Qty.	Panel/Top	Colors
30606GY	Low Profile Floor Rack	52-5/8	40	27	–	–	–	–	–	500 per side/250	–
30606GY240	Low Profile Floor Rack	52-5/8	40	27	30240	14-3/4	8-1/4	7	48	500 per side/250	B, R, Y, SC
30606GY250	Low Profile Floor Rack	52-5/8	40	27	30250	14-3/4	16-1/2	7	24	500 per side/250	B, R, Y, SC
30606GYASST	Low Profile Floor Rack	52-5/8	40	27	30240 / 30250	See Above			24 / 12	500 per side/250	B, R, Y, SC
30607GY	Low Profile Floor Rack no Shelf	52-5/8	39-7/8	27	–	–	–	–	–	500	B, R, Y, SC
30607GY240	Low Profile Floor Rack no Shelf	52-5/8	39-7/8	27	30240	14-3/4	8-1/4	7	48	500	B, R, Y, SC
30607GY250	Low Profile Floor Rack no Shelf	52-5/8	39-7/8	27	30250	14-3/4	16-1/2	7	24	500	B, R, Y, SC
30607GYASST	Low Profile Floor Rack no Shelf	52-5/8	39-7/8	27	30240 / 30250	See Above			24 / 12	500	B, R, Y, SC

30606DOLLY Dolly for 30506 or 30607 53 27-1/2 5-7/8 – – – – – 3600* –
Specify color of bins when ordering. B=Blue, R=Red, Y=Yellow, SC=Clear. *Do not exceed weight capacity of Low-Profile Rack.

Benchtop Spinner Rack : Louvered Bench Rack

LOUVERED TABLETOP STORAGE FOR HANGING BINS



Double-Sided Benchtop Spinner Rack

TABLETOP STORAGE SPACE IN A COMPACT 18" FOOTPRINT



FEATURES

- 1 18" W x 32" H louvered panel
- 2 Frame components are made of 16-gauge steel with a durable powder-coated finish
- 3 Four roller bearings allow for smooth revolving on base
- 4 Can be permanently mounted to any work surface for added stability

UP TO 200 LBS.



NEW!

Rotates!

ACCESSORIES

Suspension Straps Model No 98400
Hang 19-Series Cabinets securely to Benchtop Rack



COLOR
Gray



Double-Sided Benchtop Spinner Rack			Dimensions (In.)			Rack Wt. Cap. (lbs.)*	Bin Quantity – AkroBin Model No.					Universal Hanging Bin Model No.		19-Series Cabinet
Model No.	Description	Ctn. Qty	W	D	H		30210	30220	30224	30230	30237	36110	36120	
98318GY	Benchtop Spinner Rack	1	18-1/2	16	34-1/4	200	56	56	40	30	20	20	40	4

*Weight evenly distributed on both sides of unit.

AkroBin Louvered Benchtop Rack Packages

Model No.	Description	Bin Model No.	Bin Qty.
98318GY2430	Rack with AkroBins	30224 / 30230	24 / 12
98318GY2055	Rack with AkroBins	30220 / 30255	24 / 6

Specify color of bins when ordering. B=Blue, R=Red, Y=Yellow, SC=Clear.

Louvered Bench Rack

KEEP PARTS AND SUPPLIES IN EASY REACH



98600 with 30220

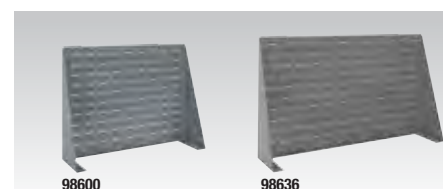

98600

98636

COLORS
Gray, Beige



Louvered Bench Rack			Dimensions (In.)			Rack Wt. Cap. (lbs.)	AkroBin Quantity to Fit Louvered Hanging System – AkroBins Model No.													
Model No.	Description	Ctn. Qty	L	W	H		30210	30220	30224	30230	30234	30235	30237	30239	30240	30250	30255	30260	30265	30320
98600*	Bench Rack	1	27-15/16	8-9/16	19-9/16	120	30	30	18	12	12	6	12	6	6	-	-	2	3	-
98636	Bench Rack	1	36	8	20	120	40	40	24	18	18	9	15	8	8	4	6	3	8	3

*Also available in Beige.

Lean Panel™ : Lean Floor Rack

ANGLED LOUVERED HANGING SYSTEM

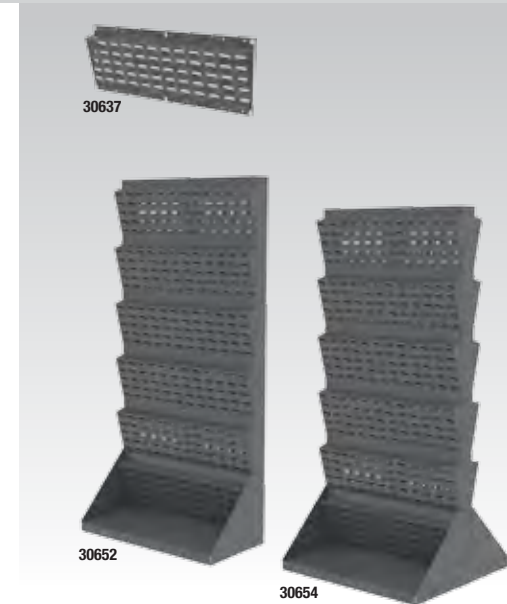
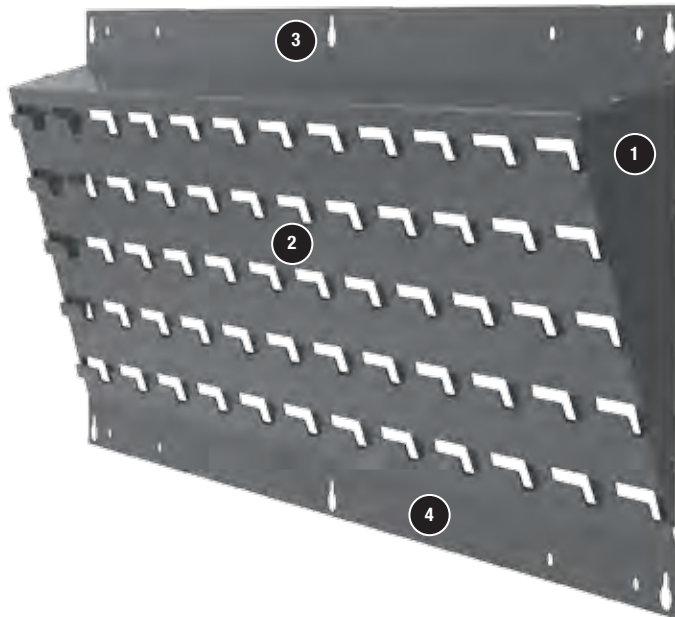

COLOR
Gray



FEATURES



- 1 Keeps hanging bins at an ergonomic 15-degree angle for easier visibility and more comfortable picking
- 2 Louvers allow for easy placement of AkroBins® or InSight® Bins
- 3 Individual panels can be wall mounted or used with floor standing racks
- 4 Durable powder-coated finish on heavy-duty 16-gauge steel



Lean Panel & Lean Panel Floor Rack		Dimensions (In.)			
Model No.	Description	L	W	H	Weight Capacity
30637A	Lean Panel – 1 PACK	35-1/2	2-1/2	13-1/4	90 lbs.
30637	Lean Panel – 3 PACK	35-1/2	2-1/2	13-1/4	90 lbs. ea.
30652	Single-Sided Floor Rack	35-3/4	17	75-1/8	500 lbs.
30654	Double-Sided Floor Rack	35-3/4	32	75-1/8	1000 lbs.
30653DOLLY	Mobile Kit for Floor Rack	–	–	–	500 lbs.

AkroBin Quantities for Lean Panel & Lean Panel Floor Rack

Model No.	30210, 30220	30224	30230, 30234	30239, 30240, 30265	30235	30237	30260	30255, 30265	30250, 30270	30320
30637A	24	16	12	4	6	10	3	4	2	2
30652	144	96	72	24	36	60	18	24	12	12
30654	288	192	144	48	72	120	36	48	24	24



30654 with 30653DOLLY (Bins sold separately)

IMAGE INCLUDES:

30654 1
 30653DOLLY . . . 1
 30220RED . . . 16
 30320BLUE . . . 2
 30230GREEN 12
 30235YELLOW . . 6
 30255RED . . . 4
 30234BLUE . . 12
 30240GREEN . . 8
 30260YELLOW . . 6
 30250RED . . . 4

ReadySpace® Storage System

BIN HANGING SYSTEMS FOR MEDICAL & PHARMACY



Ready, Set, Organize!®



PRODUCT HIGHLIGHTS

- **CLEAN** – Durable white powder-coated finish creates a neat, attractive storage space in any medical or pharmacy environment
- **MOBILE FLOOR UNIT** – Lockable casters transport supplies to where they are needed
- **WALL UNIT** – Ships complete with its own mounting bracket for easy installation
- **BENCH UNIT** – 2-piece base allows for assembly as a single- or double-sided unit
- **VARIETY** – Preconfigured packages with Stone AkroBins® are available, or create your own system using AkroBins and InSight® Bins!
- **FLEXIBILITY** – **NEW!** Louvered Panel Hooks are great for hanging tools, rolls of tape, hoses and tubing, therapy bands and more (see page 33)



30536
Wall Unit



98536
Bench Unit



30553
Mobile Floor Unit
with Louvered Panel Hooks
(see page 33)

ReadySpace Wall Unit Packages		Capacity/Qty.		
Model No.	Description (L x D x H)	No. of Ctns.	Wt. Cap. (lbs.)	Bin Qty.
30536	37-1/2" x 1-3/4" x 25-3/8", Panel	1	50	N/A
30536210S	Unit with 30210STONE Bins	3	50	48
30536220S	Unit with 30220STONE Bins	3	50	48
30536230S	Unit with 30230STONE Bins	3	50	24
30536235S	Unit with 30235STONE Bins	3	50	12
30536320S	Unit with 30320STONE Bins	2	50	4
30536A1	ReadySpace Wall Unit with 305A1	4	50	48
30536A3	ReadySpace Wall Unit with 305A3	4	50	48
30536A5	ReadySpace Wall Unit with 305A5	5	50	48
30536B1	ReadySpace Wall Unit with 305B1	3	50	24

ReadySpace Mobile Floor Unit Packages		Capacity/Qty.		
Model No.	Description (L x D x H)	No. of Ctns.	Wt. Cap. (lbs.)	Bin Qty.
30553	24-5/8" x 23" x 52"	1	150	N/A
30553210S	Unit with 30210STONE Bins	6	150	120
30553220S	Unit with 30220STONE Bins	6	150	120
30553230S	Unit with 30230STONE Bins	6	150	60
30553235S	Unit with 30235STONE Bins	6	150	30
30553A1	ReadySpace Mobile Floor Unit with 305A1	9	150	120
30553A3	ReadySpace Mobile Floor Unit with 305A3	9	150	120
30553A5	ReadySpace Mobile Floor Unit with 305A5	11	150	120
30553B1	ReadySpace Mobile Floor Unit with 305B1	7	150	64
30553LF	Leveling Feet for Floor Unit	-	150	-

ReadySpace Bench Unit Packages		Capacity/Qty.		
Model No.	Description (L x D x H)	No. of Ctns.	Wt. Cap. (lbs.)	Bin Qty.
98536	37-3/4" x 12" x 26-3/8" (Single)	1	100	N/A
98536210SS	Single-Sided Bench Unit with 30210STONE Bins	3	100	48
98536220SS	Single-Sided Bench Unit with 30220STONE Bins	3	100	48
98536230SS	Single-Sided Bench Unit with 30230STONE Bins	3	100	24
98536235SS	Single-Sided Bench Unit with 30235STONE Bins	3	100	12
98536320SS	Single-Sided Bench Unit with 30320STONE Bins	2	100	4
98536	37-3/4" x 22-1/2" x 26-3/8" (Double)	1	100	N/A
98536210SD	Double-Sided Bench Unit with 30210STONE Bins	5	100	96
98536220SD	Double-Sided Bench Unit with 30220STONE Bins	5	100	96
98536230SD	Double-Sided Bench Unit with 30230STONE Bins	5	100	48
98536235SD	Double-Sided Bench Unit with 30235STONE Bins	5	100	24
98536320SD	Double-Sided Bench Unit with 30320STONE Bins	3	100	8

COLOR
White





Rail Hanging Systems

IDEAL SYSTEMS FOR WORKSTATIONS



FEATURES

- 1 14-gauge steel rails securely support AkroBins®, 19-Series Cabinets and InSight® Ultra-Clear Bins (sold separately)
- 2 Heavy-duty steel for strength and durability
- 3 Durable powder-coated finish

PRODUCT HIGHLIGHTS

- **EFFICIENT** – Allow for fast, easy organization and parts retrieval
- **SINGLE-SIDED** – Units are ideal for placement against a wall to save space
- **DOUBLE-SIDED** – Units can “float” in any room environment and can be picked from both sides
- **MOBILE KIT** – Available to mobilize two-sided rack
- **STEEL RAIL** – Wall mountable rail is ideal for supply rooms and workstations



HOW TO CHOOSE: Rails vs. Louvers

Rails: Constructed of individual steel rails that span between uprights. Weigh less than louvered panels, more economical, small footprint, easy to remove bins from rails.

Louvers: (Page 32) Steel panels with rows of punched louvers. More storage capacity, greater selection of styles. Panels can be attached to the wall, freeing floor space. Rivet racks come with the panels already riveted to the frame.

Rail Hanging Systems				Dimensions (In.)			AkroBins Model No.‡												InSight Bins ‡				19-Series Cabinets		
Model No.	Description	Wt. Cap.	Ctn. Qty.	L	W	H	30210	30220	30224	30230	30234	30235	30237	30239	30240	30250	30255	30260	30265	30270	305A1	305A3	305A5	305B1	
30008*	Rack, 1-Sided	250	1	36	14-1/8	53	96	96	48	48	48	24	40	24	24	12	16	12	16	8	96	96	96	48	6
30016*	Rack, 2-Sided	500	1	36	20	53	192	192	96	96	96	48	80	48	48	24	32	24	32	16	192	192	192	96	12
30148	Steel Rail	110	1	47-13/16	5/8	3	11	11	11	8	8	4	8	4	4	2	2	4	5	2	11	11	11	8	2
30812	Bin Cart	250	1	38-1/2	24	36-1/2	96	96	64	48	48	24	40	24	24	12	16	12	16	8	96	96	96	48	12

*Can be assembled as a 12 or 16 rail rack. †Do not exceed rail weight capacity.

Mobile Kit					
Model No.	Description	Wt. Cap.	Ctn. Qty.	Fits Hanging System No.	Casters
30424	Mobile Kit - Casters & Handle	500	1	30016	4" Polyolefin
98400	Suspension Straps (Set of 2) ‡‡	—	1	30008, 30016, 30812	—

‡‡98400 suspension straps required for hanging 19-Series Cabinets. Two straps per cabinet needed to secure cabinet to rack.

ACCESSORIES

Suspension Straps
Model No 98400
Hang 19-Series Cabinets
securely to rail rack



30016 with (1) 30424, (12) 98400, (12) 19320

Pick Racks

HIGH-DENSITY STORAGE WITH ANGLED SHELVES



UP TO 1800 LBS.

APRD162 with APRDMOBILE



COLOR Gray



APRBENCH



APRS



APRD18



FEATURES

- 1 16-gauge steel construction
- 2 Angled shelves keep parts at the front of bin
- 3 Works with Akro-Mils' industry-leading Shelf Bins, ShelfMax® Bins, Indicator® Bins, AkroDrawers® and System Bins™
- 4 Durable, powder-coated finish

PRODUCT HIGHLIGHTS

- **EFFICIENT** – Improve workspace organization and efficiency
- **HEAVY-DUTY** – Up to 1,800 lb. capacity with Double-Sided 18" Racks
- **VARIETY** – Choose from 3 styles: Single-Sided, Double-Sided, Bench, and two shelf depths: 12" and 18"

Bench Rack 12" D x 36 3/4" W x 25" H			Bin Dimensions (In.)			
Model No.	Description	Bin Model No.	L	W	H	Bin Qty.
APRBENCH	Bench Pick Rack, No Bins	–	–	–	–	–
APRBENCH120*	Bench Pick Rack with Shelf Bins	30120	11-5/8	4-1/8	4	24
APRBENCH150*	Bench Pick Rack with Shelf Bins	30150	11-5/8	8-3/8	4	12
APRBENCH040**	Bench Pick Rack with ShelfMax	30040	11-5/8	4-1/8	6	24
APRBENCH090**	Bench Pick Rack with ShelfMax	30090	11-5/8	6-5/8	6	15
APRBENCH010	Bench Pick Rack with ShelfMax	30010	11-5/8	11-1/8	6	16†
APRBENCH312	Bench Pick Rack with System Bins	30312	12	33	5	3

*Specify color of Shelf Bins when ordering: Red, Blue, Yellow, Green or White. **Specify color of ShelfMax Bins when ordering: Red, Blue, Yellow or Crystal Clear. †Bonus bins included.

12" Deep Pick Rack 12" D x 36 3/4" W x 60 1/4" H				Shelf Dimensions (in.)		
Model No.	Description	Wt. Capacity (Lbs.)	Caster	D	L	H
APRS	Single-Sided Pick Rack (no bins)	400	–	12-1/8	35-5/8	6-7/16
APRD	Double-Sided Pick Rack (no bins)	800	–	12-1/8	35-5/8	6-7/16
APRDMOBILE	Mobile Kit (Handle & Dolly) for Double-Sided Pick Rack	500	4" x 1 1/2" Polyolefin	–	–	–

18" Deep Pick Rack 18" D x 36 3/4" W x 60 1/4" H				Shelf Dimensions (In.)		
Model No.	Description	Wt. Capacity (Lbs.)	Caster	D	L	H
APRS18	Single-Sided Pick Rack (no bins)	900*	–	18-1/8	35-5/8	6-7/16
APRD18	Double-Sided Pick Rack (no bins)	1800**	–	18-1/8	35-5/8	6-7/16
APRD18MOBILE	Mobile Kit (Handle & Dolly) for Double-Sided Pick Rack	1800	5" x 2" Phenolic	–	–	–

*When anchored to wall and floor. **When anchored to floor.

Pick Rack Systems

12" DEEP ANGLED SHELVES

Shelf Bins



APRS170G

ShelfMax Bins



APRD080B

Indicator Bins

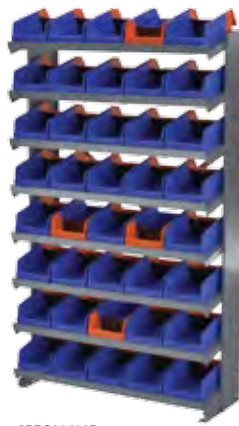

APRS36462B

AkroDrawer Bins



APRD182CRY

System Bins



APRD312R

12" Deep Single-Sided Pick Rack			Bin Dimensions (In.)				
Model No.	Description	Bin Model No.	L	W	H	Bin Qty.	Colors
Shelf Bins							
APRS110	Rack with Shelf Bins	30110	11-5/8	2-3/4	4	96	B,R,Y,G,W,SC
APRS120	Rack with Shelf Bins	30120	11-5/8	4-1/8	4	64‡	B,R,Y,G,W,SC
APRS130	Rack with Shelf Bins	30130	11-5/8	6-5/8	4	40‡	B,R,Y,G,W,SC
APRS150	Rack with Shelf Bins	30150	11-5/8	8-3/8	4	32‡	B,R,Y,G,W,SC
APRS170	Rack with Shelf Bins	30170	11-5/8	11-1/8	4	24	B,R,Y,G,W,SC
ShelfMax Bins							
APRS040	Rack with ShelfMax	30040	11-5/8	4-1/8	6	64	B,R,Y,SC
APRS080	Rack with ShelfMax	30080	11-5/8	8-3/8	6	32	B,R,Y,SC
APRS090	Rack with ShelfMax	30090	11-5/8	6-5/8	6	40	B,R,Y,SC
APRS010	Rack with ShelfMax	30010	11-5/8	11-1/8	6	24	B,R,Y,SC
APRSAST00	Rack with ShelfMax	30040 / 30090	See above			32 / 20	B,R,Y,SC
Indicator Bins							
APRS36442B	Rack with Indicator Bins	36442BLUE	11-5/8	4-1/4	4	64‡	B
APRS36462B	Rack with Indicator Bins	36462BLUE	11-5/8	6-3/4	4	40‡	B
AkroDrawers							
APRS112	Rack with AkroDrawers	31112	11-5/8	11-1/8	4-5/8	24	B,R,Y,GRY,CRY
APRS142	Rack with AkroDrawers	31142	11-5/8	3-3/4	4-5/8	72	B,R,Y,GRY,CRY
APRS162	Rack with AkroDrawers	31162	11-5/8	5-9/16	4-5/8	48	B,R,Y,GRY,CRY
APRS182	Rack with AkroDrawers	31182	11-5/8	8-3/8	4-5/8	32	B,R,Y,GRY,CRY
APRSAST	Rack with AkroDrawers	31142, 31162, 31182	See Above			18 / 24 / 8	B,R,Y,GRY,CRY
System Bins							
APRS312	Rack with System Bins	30312	12	33	5	8‡	B,R,Y

Specify color of bins when ordering. ‡Bonus bins included. B=Blue, R=Red, Y=Yellow, G=Green, W=White, SC=Clear, GRY=Gray, CRY=Crystal Clear.

12" Deep Double-Sided Pick Rack			Bin Dimensions (In.)				
Model No.	Description	Bin Model No.	L	W	H	Bin Qty.	Colors
Shelf Bins							
APRD110	Rack with Shelf Bins	30110	11-5/8	2-3/4	4	192	B,R,Y,G,W,SC
APRD120	Rack with Shelf Bins	30120	11-5/8	4-1/8	4	128‡	B,R,Y,G,W,SC
APRD130	Rack with Shelf Bins	30130	11-5/8	6-5/8	4	80‡	B,R,Y,G,W,SC
APRD150	Rack with Shelf Bins	30150	11-5/8	8-3/8	4	64‡	B,R,Y,G,W,SC
APRD170	Rack with Shelf Bins	30170	11-5/8	11-1/8	4	48	B,R,Y,G,W,SC
ShelfMax Bins							
APRD040	Rack with ShelfMax	30040	11-5/8	4-1/8	6	128	B,R,Y,SC
APRD080	Rack with ShelfMax	30080	11-5/8	8-3/8	6	64	B,R,Y,SC
APRD090	Rack with ShelfMax	30090	11-5/8	6-5/8	6	80	B,R,Y,SC
APRD010	Rack with ShelfMax	30010	11-5/8	11-1/8	6	48	B,R,Y,SC
APRDAST00	Rack with ShelfMax	30040 / 30090	See above			64 / 40	B,R,Y,SC
Indicator Bins							
APRD36442B	Rack with Indicator Bins	36442BLUE	11-5/8	4-1/4	4	128‡	B
APRD36462B	Rack with Indicator Bins	36462BLUE	11-5/8	6-3/4	4	80‡	B
AkroDrawers							
APRD112	Rack with AkroDrawers	31112	11-5/8	11-1/8	4-5/8	48	B,R,Y,GRY,CRY
APRD142	Rack with AkroDrawers	31142	11-5/8	3-3/4	4-5/8	144	B,R,Y,GRY,CRY
APRD162	Rack with AkroDrawers	31162	11-5/8	5-9/16	4-5/8	96	B,R,Y,GRY,CRY
APRD182	Rack with AkroDrawers	31182	11-5/8	8-3/8	4-5/8	64	B,R,Y,GRY,CRY
APRDAST	Rack with AkroDrawers	31142, 31162, 31182	See Above			36 / 48 / 16	B,R,Y,GRY,CRY
System Bins							
APRD312	Rack with System Bins	30312	12	33	5	16‡	B,R,Y

Specify color of bins when ordering. ‡Bonus bins included. B=Blue, R=Red, Y=Yellow, G=Green, W=White, SC=Clear, GRY=Gray, CRY=Crystal Clear.

Pick Rack Systems

18" DEEP ANGLED SHELVES

Shelf Bins

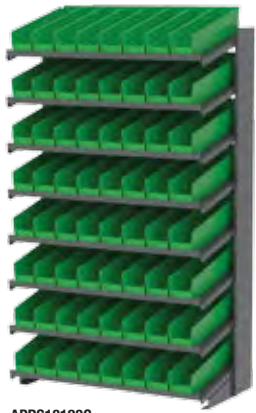

APRS18128G

ShelfMax Bins

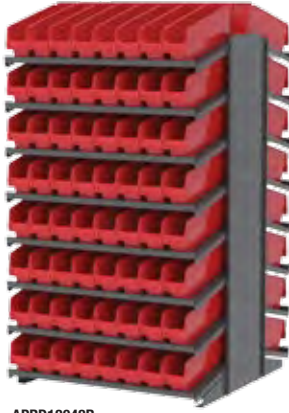

APRD18048R

Indicator Bins



APRS1836448B

AkroDrawer Bins



APRD18148B

System Bins

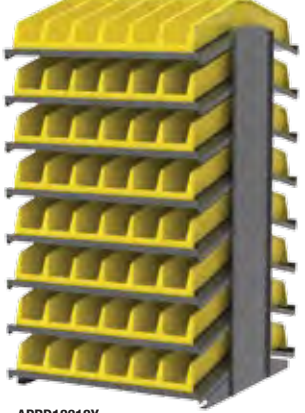

APRD18318Y

18" Deep Single-Sided Pick Rack			Bin Dimensions (In.)				
Model No.	Description	Bin Model No.	L	W	H	Bin Qty.	Colors
Shelf Bins							
APRS18128	Rack with Shelf Bins	30128	17-7/8	4-1/8	4	72‡	B,R,Y,G,W,SC
APRS18138	Rack with Shelf Bins	30138	17-7/8	6-5/8	4	48‡	B,R,Y,G,W,SC
APRS18158	Rack with Shelf Bins	30158	17-7/8	8-3/8	4	36‡	B,R,Y,G,W,SC
APRS18178	Rack with Shelf Bins	30178	17-7/8	11-1/8	4	24	B,R,Y,G,W,SC
ShelfMax Bins							
APRS18048	Rack with ShelfMax	30048	17-7/8	4-1/8	6	64	B,R,Y,SC
APRS18088	Rack with ShelfMax	30088	17-7/8	8-3/8	6	32	B,R,Y,SC
APRS18098	Rack with ShelfMax	30098	17-7/8	6-5/8	6	40	B,R,Y,SC
APRS18018	Rack with ShelfMax	30018	17-7/8	11-1/8	6	24	B,R,Y,SC
APRS18AST00	Rack with ShelfMax	30048 / 30098	See above			32/20	B,R,Y,SC
Indicator Bins							
APRS1836448	Rack with Indicator Bins	36448BLUE	17-7/8	4-1/8	4	72‡	B
APRS1836468	Rack with Indicator Bins	36468BLUE	17-7/8	6-5/8	4	48‡	B
AkroDrawers							
APRS18148	Rack with AkroDrawers	31148	17-5/8	3-3/4	4-5/8	72	B,R,Y,GRY,CRY
APRS18168	Rack with AkroDrawers	31168	17-5/8	5-9/16	4-5/8	48	B,R,Y,GRY,CRY
APRS18188	Rack with AkroDrawers	31188	17-5/8	8-3/8	4-5/8	32	B,R,Y,GRY,CRY
APRS18118	Rack with AkroDrawers	31118	17-5/8	11-1/8	4-5/8	24	B,R,Y,GRY,CRY
System Bins							
APRS18318	Rack with System Bins	30318	18	33	5	8‡	B,R,Y

Specify color of bins when ordering. ‡Bonus bins included. B=Blue, R=Red, Y=Yellow, G=Green, W=White, SC=Clear, GRY=Gray CRY=Crystal Clear.

18" Deep Double-Sided Pick Rack			Bin Dimensions (In.)				
Model No.	Description	Bin Model No.	L	W	H	Bin Qty.	Colors
Shelf Bins							
APRD18128	Rack with Shelf Bins	30128	17-7/8	4-1/8	4	132‡	B,R,Y,G,W,SC
APRD18138	Rack with Shelf Bins	30138	17-7/8	6-5/8	4	84‡	B,R,Y,G,W,SC
APRD18158	Rack with Shelf Bins	30158	17-7/8	8-3/8	4	72‡	B,R,Y,G,W,SC
APRD18178	Rack with Shelf Bins	30178	17-7/8	11-1/8	4	48	B,R,Y,G,W,SC
ShelfMax Bins							
APRD18048	Rack with ShelfMax	30048	17-7/8	4-1/8	6	128	B,R,Y,SC
APRD18088	Rack with ShelfMax	30088	17-7/8	8-3/8	6	64	B,R,Y,SC
APRD18098	Rack with ShelfMax	30098	17-7/8	6-5/8	6	80	B,R,Y,SC
APRD18018	Rack with ShelfMax	30018	17-7/8	11-1/8	6	48	B,R,Y,SC
APRD18AST00	Rack with ShelfMax	30048 / 30098	See above			64/40	B,R,Y,SC
Indicator Bins							
APRD1836448	Rack with Indicator Bins	36448BLUE	17-7/8	4-1/8	4	132‡	B
APRD1836468	Rack with Indicator Bins	36468BLUE	17-7/8	6-5/8	4	84‡	B
AkroDrawers							
APRD18148	Rack with AkroDrawers	31148	17-5/8	3-3/4	4-5/8	144	B,R,Y,GRY,CRY
APRD18168	Rack with AkroDrawers	31168	17-5/8	5-9/16	4-5/8	96	B,R,Y,GRY,CRY
APRD18188	Rack with AkroDrawers	31188	17-5/8	8-3/8	4-5/8	64	B,R,Y,GRY,CRY
APRD18118	Rack with AkroDrawers	31118	17-5/8	11-1/8	4-5/8	48	B,R,Y,GRY,CRY
System Bins							
APRD18318	Rack with System Bins	30318	18	33	5	16‡	B,R,Y

Specify color of bins when ordering. ‡Bonus bins included. B=Blue, R=Red, Y=Yellow, G=Green, W=White, SC=Clear, GRY=Gray CRY=Crystal Clear.



Storage Cases : Utility Boxes : Portable Organizers

CUSTOMIZABLE, LIGHTWEIGHT, PORTABLE BOXES

Clear Storage Cases

GRIDDED LID KEEPS ITEMS IN PLACE



FEATURES

- 1 Grid design in lid keeps items from spilling into other compartments
- 2 Dividers are adjustable for customized storage

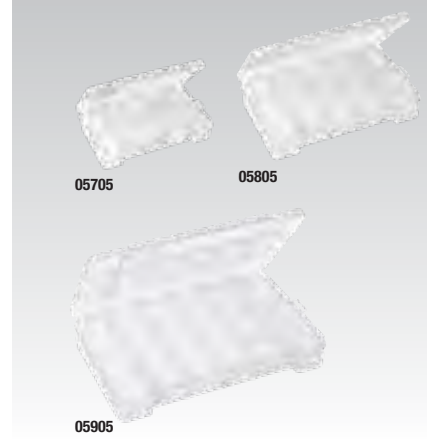

PRODUCT HIGHLIGHTS

- **FUNCTIONAL** – Plastic storage cases are ideal in any setting for parts storage
- **ADJUSTABLE** – Cases include front-to-back adjustable dividers
- **DURABLE** – Molded of clear industrial-grade polymers



COLOR
Clear



Small & Medium Cases

2 Fixed Dividers
4 Adjustable Dividers

Large Cases

2 Fixed Dividers
5 Adjustable Dividers

Storage Cases		Dimensions (In.)			Capacity/Qty.	
Model No.	Description	L	W	H	Maximum Compartments	Ctn. Qty.
05705	Small Case – 2 Fixed Dividers; 4 Adjustable Dividers	8-5/8	5-1/8	1-5/8	15	12
05805	Medium Case – 2 Fixed Dividers; 4 Adjustable Dividers	11	7	2-3/8	15	6
05905	Large Case – 2 Fixed Dividers; 5 Adjustable Dividers	14-3/8	9-1/2	2-1/2	18	6

Order in carton quantities.

Utility Boxes

- **VERSATILE** – Perfect for kits
- **ADJUSTABLE** – Includes 2 adjustable dividers
- **FLAT LID** – For easy labeling of case contents

COLOR
Clear



Utility Boxes		Dimensions (In.)			Capacity/Qty.	
Model No.	Description	L	W	H	Maximum Compartments	Ctn. Qty.
96352A	Medium Utility Box – 5 Fixed Dividers	8-5/16	4-5/8	1-1/2	18	12
96352B	Large Utility Box – 4 Fixed Dividers	11	6-3/8	2-1/2	15	6

Order in carton quantities.

Portable Organizers



- **FUNCTIONAL** – Unique design keeps parts from migrating to other compartments when the lid is shut
- **DIVIDABLE** – Adjustable dividers included for customized storage in both levels

COLOR
Blue/Clear



Portable Organizers		Dimensions (In.)			Capacity/Qty.	
Model No.	Description	L	W	H	Maximum Compartments	Ctn. Qty.
06115	Lid Storage Organizer	15	11-5/16	3-1/4	11 to 46	1
06118	Large Lid Storage Organizer	18-1/4	13-3/8	3-3/8	12 to 62	1

Order in carton quantities.



Roto-Shelf : Tote Caddy : ProBox™ Toolboxes

SMALL PARTS STORAGE



UP TO 300 LBS.

MADE IN THE USA

Roto-Shelf



- **MOBILE** – Roto-Shelf can be moved easily to different work areas; ideal for assembly components
- **FUNCTIONAL** – 24 individual storage compartments
- **COMPACT** – 19⁷/₈" wide unit takes up little floor space
- **ROTATING** – 3 shelves rotate on an independent central metal shaft
- **CAPACITY** – 75 lbs. per shelf, 300 lbs. total capacity

COLOR Black/Red



Roto-Shelf		Dimensions (In.)			Caster	Ctn. Qty.
Model No.	Description	D	H			
02420	Roto-Shelf	19-7/8	37-1/2	3" Polyurethane		1



MADE IN THE USA

AVAILABLE IN CLEAR



Tote Caddy



- **COMPACT** – Hand-held tool and supply caddy
- **FUNCTIONAL** – Deep compartments hold loose parts, cleaning supplies or tools for easy transport; two shallow compartments are perfect for hardware, keys or loose items
- **DURABLE** – Molded of heavy-duty, industrial-grade polymers with a textured finish for lasting durability

COLORS Blue, Clear



Tote Caddy		Dimensions (In.)			Ctn. Qty.
Model No.	Description	L	W	H	
09185BLUE	Tote Caddy - Blue	13-7/8	18-3/8	9	6
09185SCLEAR	Tote Caddy - Clear	13-7/8	18-3/8	9	6

Order in carton quantities.



09514



09912

MADE IN THE USA

ProBox™ Toolboxes



- **FUNCTIONAL** – 14" unit includes removable tool tray and metal latch*
- **SECURE** – 14" unit features oversized padlock eye

COLOR Red



ProBox Toolbox		Dimensions (In.)			Ctn. Qty.
Model No.	Description	L	W	H	
09912*	12" ProBox	12	6	4	12
09514	14" ProBox	14	8-1/8	8-1/8	6

Order in carton quantities. *12" unit does not include tray.



TiltView®

TILTING BINS OFFER VISIBLE, DUST-FREE STORAGE



FEATURES

- 1 Cabinets made of high-impact polystyrene
- 2 Bins made of polystyrene (GPS)
- 3 Molded-in label holder (card stock labels included)
- 4 Neutral Stone color is ideal for any environment
- 5 06702 slides apart to form two separate bins

PRODUCT HIGHLIGHTS

- **EFFICIENT** – Space-saving system will improve organization and efficiency in a variety of settings, including medical and pharmacy!
- **FUNCTIONAL** – Can be used on a desktop, attached to steel rails, frames or louvered panels, and are wall mountable
- **VARIETY** – Available in 6 sizes



06702



06703



06704



06705



06706



06709

COLOR
Stone



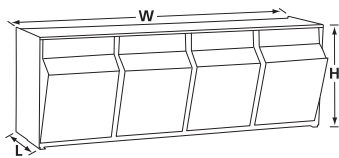

TiltView Bins		Dimensions (In.)			Capacity/Qty.		Accessories	
Model No.	Description	L	W	H	Ctn. Qty.	Capacity Lbs.	Dividers	Replacement Cups
06702	2-Bin TiltView	12-5/16	23-5/8	14	1	30	–	06702CUP
06703	3-Bin TiltView	7-7/8	23-5/8	9-7/16	1	30	40703 (3/Pk)	06703CUP
06704	4-Bin TiltView	6-3/4	23-5/8	8-3/16	1	25	40704 (4/Pk)	06704CUP
06705	5-Bin TiltView	5-3/8	23-5/8	6-1/2	1	20	–	06705CUP
06706	6-Bin TiltView	3-3/4	23-5/8	4-1/2	1	15	–	06706CUP
06709	9-Bin TiltView	2-1/2	23-5/8	3-3/16	1	5	–	06709CUP

TiltView Accessories		
Model No.	Description	Ctn. Qty.
TVHDWR	TiltView Hardware Pack (need 1 set per unit)	1 Set
TVLRA	TiltView Locking Rod	2 Pk.
TVLR	TiltView Locking Rod	12 Pk.
TVCLIP	TiltView Hanging Clip	2 Pk.

TiltView Rails		Dimensions (In.)			Number of Bins to Fit Each Rail Set					
Model No.	Description	L	W	H	06702	06703	06704	06705	06706	06709
TV24R	24" TiltView Rails	1-1/8	1-3/8	24-1/8	1	2	3	3	5	8
TV48R	48" TiltView Rails	1-1/8	1-3/8	48-1/8	3	5	6	7	10	16
TV70R	70" TiltView Rails	1-1/8	1-3/8	70-1/8	5	7	8	10	15	23

One Rail Set = 2 Rails. Bins sold separately; mounting bins requires hardware pack.

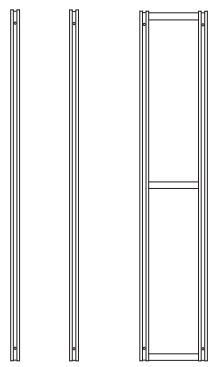

TiltView Frames		Dimensions (In.)			Number of Bins to Fit Each Frame					
Model No.	Description	L	W	H	06702	06703	06704	06705	06706	06709
TV24F	24" TiltView Frames	1-1/8	13-1/4	24-1/8	1	2	3	3	5	8
TV48F	48" TiltView Frames	1-1/8	13-1/4	48-1/8	3	5	6	7	10	16
TV70F	70" TiltView Frames	11/8	13-1/4	70-1/8	5	7	8	10	15	23

Bins sold separately; mounting bins requires hardware pack.

ACCESSORIES



Dividers
Optional dividers (for 3-Bin and 4-Bin models) expand sorting options



Wall Mount Frames
16-gauge steel frames make a system where bin units are easily stacked and removed securely



TiltView Clips
Model No. TVCLIP
Allow easy attachment to Akro-Mils' Louvered Hanging Systems or the ReadySpace® Storage System



Locking Rod
Model No. TVLR
Keeps contents secure; rods easily attach to unit, and flip down to keep the bins from opening



Rail Systems
16-gauge steel rails convert bins into customizable hanging wall systems

RELATED PRODUCTS

Using the TiltView Clips, bins will attach to the following products



32-36 Louvered Hanging Systems



37 ReadySpace Storage System



38 Rail Hanging Systems



49 Heavy-Duty Cabinet Systems



52 Quick-View Cabinet Systems



Steel Storage Cabinets

17-SERIES & 19-SERIES

19-Series Cabinets

HEAVY-DUTY VERSATILE CABINET

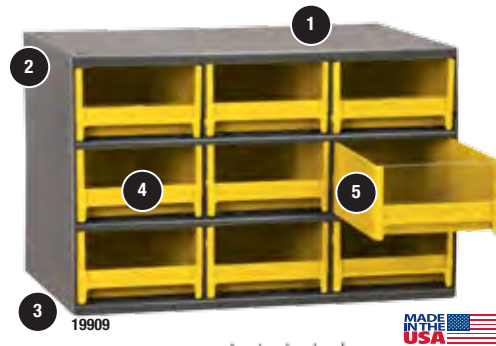

FEATURES

- 1 Chip-proof, durable powder-coated finish
- 2 Heavy-duty 24-gauge, welded-steel frame for strength
- 3 Built-in nesting feet for safe, stable stacking
- 4 Label holder and transparent window for content identification
- 5 Industrial-grade plastic drawers available in 5 colors!
- 6 Dovetail dividers lock securely in place and provide up to 8 compartments



PRODUCT HIGHLIGHTS

- **FUNCTIONAL** – The perfect choice for easy access and organization of small parts. Cabinet size: 17" wide x 11" deep x 11" high. Drawer depth: 10⁹/₁₆"
- **SAFE** – No sharp edges to damage parts. Unique rear stop tab on each drawer prevents spills
- **EXPANDABLE** – Cabinets can be used with Rail Racks, ProCart™, Storage-Go-Round, or Louvered Panels with optional Suspension Straps
- **WALL-MOUNTABLE** – 4 "keyhole slots" on back for easy wall mounting
- **VARIETY** – Available in 5 models and 5 drawer colors: Red, Blue, Yellow, Gray and Black. Cabinet with locking door also available!



19228



19320



19416



19715



19909



19109



19-Series Heavy-Duty Steel Cabinets			Drawer Dimensions (In.)				Accessories	
Model No.	Description	Drawers Per Cabinet†	W	H	D	Ctn. Qty.	Drawer Model No.	Dividers 25/Pkg. Model No.
19228	Steel Storage Cabinet	28	2-3/16	2-1/16	10-9/16	1	20228	40228
19320	Steel Storage Cabinet	20	3-3/16	2-1/16	10-9/16	1	20320	40320
19416	Steel Storage Cabinet	16	4	2-1/8	10-9/16	1	20416	40416
19715	Steel Storage Cabinet	15	3-3/16	3-1/16	10-9/16	1	20715	40715
19909	Steel Storage Cabinet	9	5-3/16	3-1/16	10-9/16	1	20909	40909
19109	Storage Cabinet w/ Locking Door	9	5-3/16	3-1/16	10-9/16	1	20909	40909
98400	Suspension Straps (Set of 2)	-	-	-	-	12 sets	-	-

One drawer color per cabinet. Specify Red, Blue, Yellow, Gray or Black when ordering. † Two removable dividers and one label per drawer included.

DRAWER COLORS

Red, Yellow, Blue, Gray, Black



CABINET COLOR

Gray



17-Series Cabinet

ECONOMICAL STEEL FRAME CABINET



- **STEEL FRAME** – 18" wide x 6" deep x 9 1/2" high
- **CRYSTAL CLEAR DRAWERS** – Rust, corrosion and dent-proof

17-Series Light-Duty Steel Cabinets			Drawer Dimensions (In.)				Accessories	
Model No.	Description	Drawers Per Cabinet†	W	H	D	Ctn. Qty.	Drawer Model No.	Dividers 25/Pkg. Model No.
17018	Storage Cabinet	18	2-3/4	2-1/2	5-3/4	1	20902	40901

† One removable divider and one label per drawer included.

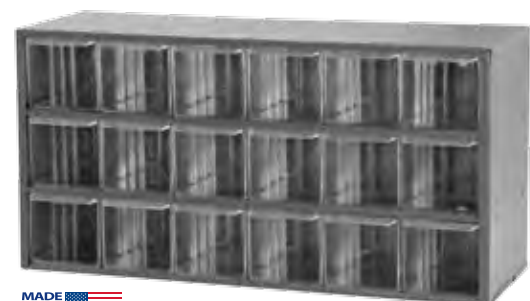

Storage-Go-Round : Mobile Steel Cabinet Rack

HIGH-DENSITY STORAGE OPTIONS



Storage-Go-Round

1,000 LBS. OF PARTS IN 1 SQUARE YARD



FEATURES

- 1 Securely holds (20) 19-Series cabinets, sold separately
- 2 Small workspace footprint: compact swing diameter 43⁵/₈"
- 3 Ball-transfer base rotates for easy access to parts
- 4 Durable, powder-coated finish
- 5 Mix or match color options and drawer sizes to take organization to the next level!

PRODUCT HIGHLIGHTS

- **EFFICIENT** – Streamlines workflow and order picking
- **DUST-FREE** – Cabinets and drawers minimize dust collection
- **CAPACITY** – Holds 20 steel cabinets; weight capacity of 1,000 lbs.
- **VARIETY** – Mix or match steel cabinet drawer colors: Red, Blue, Yellow, Gray, Black

Storage-Go-Round		Assembled Dimensions (In.)			Compatible with Models*	COLOR
Model No.	Description	L	W	H		
98325	Storage-Go-Round with turntable base	31	31	60	19228, 19320, 19416, 19715, 19909	Gray

Assembly required. * 19-Series Cabinets sold separately.

COLOR
Gray



Mobile Steel Cabinet Rack

500 LBS. OF PARTS WITHIN REACH



- **VERSATILE** – Double-sided, mobile rail rack holds up to 12 cabinets, with as many as 336 drawers
- **HEAVY-DUTY** – Supports up to 500 lbs.

COLOR
Gray



Mobile Steel Cabinet Rack		
Model No.	Description	Required Components Qty.
30016	Double-Sided Rail Rack – 36" W x 24" D x 57" H	1 each
30424	Mobile Kit	1 each
98400	Suspension Straps (Set of 2) ††	12 sets

Assembly required. See chart above. †† 98400 suspension straps required for hanging. Two straps per cabinet needed to secure cabinets to rack. Mix/match 12 19-Series Cabinets.

ACCESSORIES

Suspension Straps
Model No 98400
Hang 19-Series Cabinets securely to rail rack

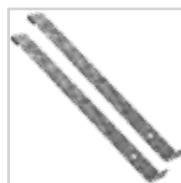

Plastic Storage Cabinets

ORGANIZE & PROTECT HARDWARE & OFFICE SMALL PARTS



10126



FEATURES

- 1 Cabinets made of rugged, high-impact plastic
- 2 Clear industrial-grade plastic drawers are unbreakable
- 3 Interlocking cabinet frame and face ensure strength and durability



PRODUCT HIGHLIGHTS

- **RECYCLED** – Cabinet frames are made of 100% recycled material. Make a positive impact on the environment!
- **FUNCTIONAL** – Strong plastic cabinets organize and protect loose items
- **STACKBLE** – Cabinets stack for more storage options
- **WALL-MOUNTABLE** – 4 “keyhole slots” on back for easy wall mounting
- **DIVIDABLE** – A limited number of drawer dividers provided. Additional dividers sold separately
- **VARIETY** – Available in 5 models



10116



10124

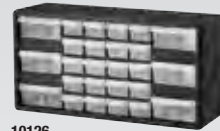

10126



10144

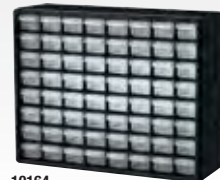

10164

COLOR

Black



Plastic Storage Cabinets		Drawer Qty.		Dimensions (In.)			Ctn. Qty.
Model No.	Description	Large 20702	Small 20701	L	W	H	
10116	16-Drawer Cabinet	0	16	10-1/2	6-3/8	8-1/2	1
10124	24-Drawer Cabinet	24	0	20	6-3/8	15-13/16	1
10126	26-Drawer Cabinet	6	20	20	6-3/8	10-1/4	1
10144	44-Drawer Cabinet	12	32	20	6-3/8	15-13/16	1
10164	64-Drawer Cabinet	0	64	20	6-3/8	15-13/16	1

16-Drawer Cabinet has 8 dividers. All other cabinets have 8 small and 4 large dividers.

Additional Dividers (Plastic Cabinets)	
Model No.	Description
40716	16-Pack additional dividers for small drawers
40717	6-Pack additional dividers for large drawers



20702 Large Drawer:
Outside Dimensions: 6" x 4 1/2" x 2 3/8"
Inside Dimensions: 4 7/8" x 4 1/4" x 2 3/8"



20701 Small Drawer:
Outside Dimensions: 6" x 2 1/4" x 1 1/8"
Inside Dimensions: 5 1/4" x 1 1/8" x 1 1/8"

RELATED PRODUCTS

Create the perfect storage solution – mix and match your Plastic Storage Cabinets with these products



42 Storage Cases



42 Portable Organizers



43 Tote Caddy



44-45 TiltView

Ready-To-Assemble Cabinet : Heavy-Duty Cabinets

SPECIALTY STORAGE CABINETS OFFER EVEN MORE OPTIONS

Ready-To-Assemble Bin Cabinet

SHIPS FLAT TO SAVE MONEY

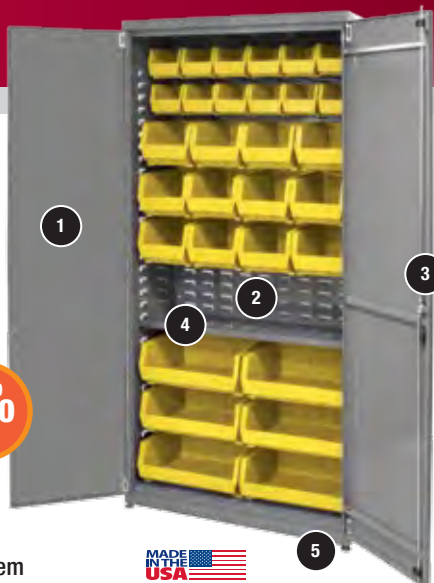

UP TO 1000 LBS.

MADE IN THE USA



FEATURES

- 1 Cabinets made of 18-gauge steel with powder-coated finish
- 2 Louvered back wall panel
- 3 Flush mount handle with 3-point locking system
- 4 100-lb. capacity shelves adjust every 2"
- 5 Leveling feet

Ready-To-Assemble Bin Cabinet 36" W x 19" D x 78" H			
Model No.	Description	Bin Model No.	Qty. of Bins
AC3618KD4AS	Ready-to-Assemble Cabinet with 4 Adjustable Shelves	-	-
AC3618KD1ASY	Ready-to-Assemble Cabinet with 1 Adjustable Shelf, 30 AkroBins	30230YELLO	12
		30240YELLO	12
		30250YELLO	6

AkroBin Model No.	L	W	H
30230	10-7/8	5-1/2	5
30240	14-3/4	8-1/4	7
30250	14-3/4	16-1/2	7



AC3618KD1ASY

AC3618KD4AS

COLOR
Gray



Optional Accessories		Dimensions (In.)			Weight Capacity
Model No.	Description	W	D	H	
AC3618RT	Rooftop	36	17-1/2	4-3/4	-
AC3618SHELF1PK	Extra Shelf	36	13	2-1/4	100 lbs.
AC803618M26	Cabinet Dolly	36-1/2	18-1/2	5-1/4	1000 lbs.
ACKEY	Replacement Key. The key is stamped 1333				

ACCESSORIES



Rooftop
Prevents potentially hazardous items from being stored on top of the cabinet

Heavy-Duty Bin Cabinets

ALL-WELDED CONSTRUCTION



PRODUCT HIGHLIGHTS

- **STURDY** – All-welded 16-gauge steel construction with 7-gauge reinforced corners
- **SECURE** – Heavy-duty steel padlock-ready handle ensures complete security
- **ADJUSTABLE** – Shelves on 2" centers allowing the flexibility of securely storing multiple-sized objects
- **DURABLE** – Powder-coated paint is resistant to cuts and scratches



HD4824E

MADE IN THE USA

Heavy-Duty Cabinet 48" W x 24" D x 72" H			Wt. Capacity (Lbs.)	AkroBin Model No.	L	W	H
Model No.	Description	Bin Model No. / Qty. of Bins	Total/Door/Shelf				
HD4824A	Cabinet w/ Shelves Only, Deep Pocket Doors	-	2000 / 250 / 300	30220	7-3/8	4-1/8	3
HD4824E	Cabinet w/ Louvered Panels on Back Wall & Doors, with Yellow AkroBins	160 - 30220YELLO; 24 - 30230YELLO; 20 - 30240YELLO; 12 - 30235YELLO	1500 / 250 / -	30230	10-7/8	5-1/2	5
				30235	10-7/8	11	5
				30240	14-3/4	8-1/4	7
HD4824F	Cabinet w/ Louvered Panels on Back Wall & Doors, with Yellow AkroBins	160 - 30220YELLO; 48 - 30230YELLO; 20 - 30240YELLO	1500 / 250 / -	30250	14-3/4	16-1/2	7
HD4824MCLAR	Cabinet w/ Louvered Panels on Back Wall & Doors, with Clear AkroBins	8 - 30240SCLAR*; 16 - 30250SCLAR*	1500 / 250 / -				

*Bonus Bins Included.



Padlock-ready handle

COLOR
Gray

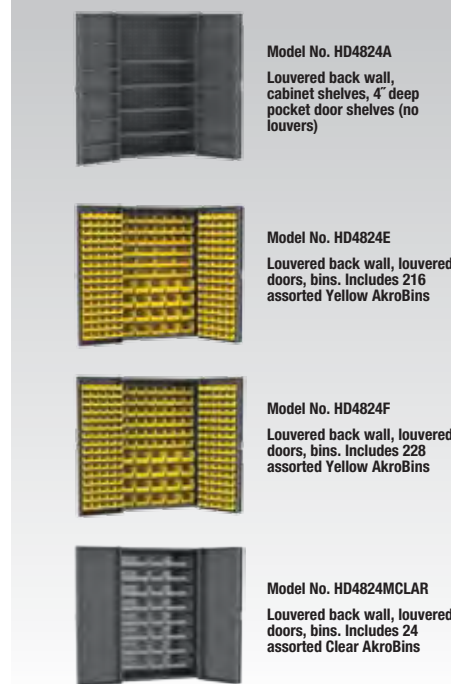

Model No. HD4824A

Louvered back wall, cabinet shelves, 4" deep pocket door shelves (no louvers)

Model No. HD4824E

Louvered back wall, louvered doors, bins. Includes 216 assorted Yellow AkroBins

Model No. HD4824F

Louvered back wall, louvered doors, bins. Includes 228 assorted Yellow AkroBins

Model No. HD4824MCLAR

Louvered back wall, louvered doors, bins. Includes 24 assorted Clear AkroBins

Standard Bin Cabinets

ALL-WELDED SOLID DOOR BIN STORAGE CABINETS



UP TO
1500
LBS.

AC36243AS

MADE IN THE USA



FEATURES

- 1 All-welded cabinets made of 16-gauge steel
- 2 Adjustable shelves hold up to 300 lbs. each
- 3 Louvered back wall panel
- 4 Keyed handle with 3-point locking system. 2 keys included. Replacement keys available, see chart

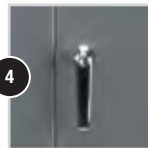

AkroBin® Cabinet
Model No. AC3624Y
Louvered panels on back wall and doors hold up to 138 bins. Weight capacity 1,200 lbs.

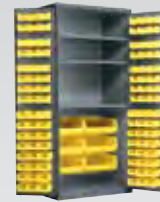

AkroBin Cabinet
with 3 Shelves
Model No. AC3624Y3AS
Louvered panels and 3 full 24" shelves hold up to 102 bins. Weight capacity 1,500 lbs.



AkroBin Cabinet
with Flush Doors
Model No. AC3618Y
Louvered panel on back wall holds up to 42 bins. Weight capacity 1,000 lbs.



Bin Cabinet Dolly
Model No. AC803624M26
Convert large cabinets to mobile units!

COLOR
Gray



AkroBin Cabinet 36" W x 24" D x 78" H			
Model No.	Description	Bin Model No.	Qty. of Bins
AC3624	Cabinet w/ Louvered Panels on Back & Doors, no Bins	-	-
AC3624Y	Cabinet w/ Louvered Panels on Back & Doors with Assorted AkroBins	30210YELLO	48
		30220YELLO	48
		30230YELLO	24
		30240YELLO	12
		30250YELLO	6

AkroBin Model No.	L	W	H
30210	5-3/8	4-1/8	3
30220	7-3/8	4-1/8	3
30230	10-7/8	5-1/2	5
30240	14-3/4	8-1/4	7
30250	14-3/4	16-1/2	7

AkroBin Cabinet w/ 3 Shelves 36" W x 24" D x 78" H			
Model No.	Description	Bin Model No.	Qty. of Bins
AC36243AS	Cabinet w/ 3 Shelves, Louvered Panels on Back & Doors, no Bins	-	-
AC3624Y3AS	Cabinet w/ 3 Shelves, Louvered Panels on Back & Doors, with Assorted AkroBins	30210YELLO	48
		30220YELLO	48
		30250YELLO	6

Bin Cabinet Dollies		Dimensions (In.)				
Model No.	Description	L	W	H	Polyolefin Casters	Weight Capacity
AC803618M26	18 x 36 Bin Cabinet Dolly	36-1/2	18-1/2	5-1/4	3 x 1-1/4"	1000 lbs.
AC803624M26	24 x 36 Bin Cabinet Dolly	36-1/2	24-1/2	6-1/2	4 x 1-1/4"	1000 lbs.

AkroBin Cabinet w/ Flush Doors 36" W x 18" D x 78" H			
Model No.	Description	Bin Model No.	Qty. of Bins
AC3618	Cabinet w/ Louvered Panels on Back Wall, no Bins	-	-
AC3618Y	Cabinet w/ Louvered Panels on Back Wall, with Assorted AkroBins	30230YELLO	24
		30240YELLO	12
		30250YELLO	6

Standard Bin Cabinet Replacement Parts	
Model No.	Description
ACKEYF	Keys for AC Cabinets built after 9/2013. Stamped FH333.
ACKEY	Keys for Mini-Cabinet and the Ready-to-Assemble Cabinet; and for AC cabinets prior to 9/2013. Stamped 1333.
AC3618SHELF1PK	Gray 18" shelf
AC3618SHELF4PK	4-pack Gray 18" shelf
AC3624SHELF3PUT	3-pack Putty 24" shelf

Standard Bin Cabinets

ALL-WELDED BIN CABINETS WITH SECURE, VIEWABLE STORAGE

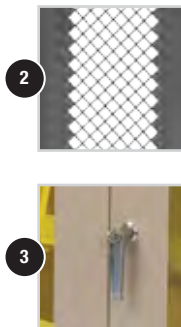

Quick-View Security Bin Cabinet
Model No. AC3618QV240
Lexan™ door panels; louvered back wall panel. Complete with 36 AkroBins. Comes standard in beige. Weight capacity 1,000 lbs.



Secure-View Security Bin Cabinet
Model No. AC3618SV240
Steel mesh door panels; louvered back wall panel. Complete with 36 AkroBins. Weight capacity 1,000 lbs.



Bin Cabinet Dolly
Model No. AC803618M26
Convert large cabinets to mobile units!



FEATURES

- 1 Durable, lightweight Lexan door panels keep out dust and debris (Quick-View)
- 2 Steel mesh door panels provide security and ventilation (Secure-View)
- 3 Keyed handle with 3-point locking system. 2 keys included. Replacement keys available, see chart on page 50

COLORS
Gray, Beige



Quick-View Security Bin Cabinet 36" W x 18" D x 78" H			
Model No.	Description	Bin Model No.	Qty. of Bins
AC3618QV	Beige Cabinet w/ Quick View Doors, Louvered Back, no Bins	-	-
AC3618QV240	Beige Cabinet w/ Quick View Doors, Louvered Back, with AkroBins	30240YELLO	36
AC3618QV250	Beige Cabinet w/ Quick View Doors, Louvered Back, with AkroBins	30250YELLO	18

AkroBin Model No.	L	W	H
30240	14-3/4	8-1/4	7
30250	14-3/4	16-1/2	7

Secure-View Security Bin Cabinet 36" W x 18" D x 78" H			
Model No.	Description	Bin Model No.	Qty. of Bins
AC3618SV	Gray Cabinet w/ Secure View Mesh Doors, Louvered Back, no Bins	-	-
AC3618SV240	Gray Cabinet w/ Secure View Mesh Doors, Louvered Back, with AkroBins	30240YELLO	36
AC3618SV250	Gray Cabinet w/ Secure View Mesh Doors, Louvered Back, with AkroBins	30250YELLO	18

Quantities for Standard Cabinets		AkroBin Quantity to Fit Standard Cabinets - AkroBins Model No.															
Model No.	Description	30210	30220	30224	30230	30234	30235	30237	30239	30240	30250	30255	30260	30265	30270	30320	
AC3618	Cabinet with Flush Doors	144	144	96	72	72	36	60	36	36	18	24	18	28	12	12	
	Back Wall	144	144	96	72	72	36	60	36	36	18	24	18	28	12	12	
AC3624	Doors	102	102	0	0	0	0	0	0	0	0	0	0	0	0	0	
	Cabinet with Louvered Doors: Total	246	246	96	72	72	36	60	36	36	18	24	18	18	12	12	



TiltView® Bin Cabinets

SECURE STORAGE; EASY ACCESS; DURABLE CABINET

Heavy-Duty Bin Cabinets

SPACE-SAVING,
HEAVY-DUTY
STORAGE



- **STURDY** – All-welded 16-gauge steel construction with 7-gauge reinforced corners
- **SECURE** – Heavy-duty steel handle with keyed padlock to ensure complete security



UP TO
2000
LBS.



HD4824TVBE



HD4824TVABCH

COLORS

Textured Charcoal Gray, Textured Putty



Padlocked handle
(2 keys included)

Heavy-Duty Cabinet 48" W x 24" D x 72" H		TiltView Bin Quantity				AkroBin Quantity
Model No.	Description	06702	06704	06705	06706	30230SCLAR
HD4824TVABBE	Beige Cabinet w/TiltView Bins, AkroBins	4	4	4	4	66
HD4824TVABCH	Charcoal Cabinet w/TiltView Bins, AkroBins	4	4	4	4	66
HD4824TVBE	Beige Cabinet w/TiltView Bins	4	4	4	4	–
HD4824TVCH	Charcoal Cabinet w/TiltView Bins	4	4	4	4	–
HD4824ABE	Beige Cabinet, Louvered Panels on Back & Doors	–	–	–	–	–
HD4824ACH	Charcoal Cabinet, Louvered Panels on Back & Doors	–	–	–	–	–

All packages include TVCLIPS needed to hang bins in cabinet.

Quick-View Security Bin Cabinets

SPACE-SAVING,
VIEWABLE STORAGE



- **VISIBLE** – Lexan™ door panels, combined with clear bins, allow easy viewing, even when cabinet is locked
- **SECURE** – Keyed handle with 3-point locking system
- **STURDY** – All-welded 16-gauge steel construction



AC3618QVTA2



UP TO
1000
LBS.



AC3618QVTA1



AC3618QVTA2

COLORS

Beige

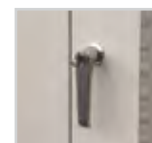

Keyed handle, 2 keys included. Replacement keys available see page 50

Quick-View Security Bin Cabinet 36" W x 18" D x 78" H		TiltView Bin Quantity					AkroBin Quantity
Model No.	Description	06702	06703	06704	06705	06706	30230SCLAR
AC3618QVTA1	Beige Cabinet w/TiltView Bins, AkroBins	–	2	3	3	1	24
AC3618QVTA2	Beige Cabinet w/TiltView Bins, AkroBins	1	1	6	1	–	24
AC3618QV	Beige Cabinet	–	–	–	–	–	–

All packages include TVCLIPS needed to hang bins in cabinet.

Secure Mini-Cabinets

LOCKABLE CABINETS HOLD 12" DEEP AKRODRAWERS®



FEATURES

- 1 Cabinets made of 18-gauge steel
- 2 Welded frame and durable powder-coated finish
- 3 Quick-View Door keeps cabinet contents visible
- 4 4 adjustable shelves
- 5 Lockable flush-mount handle (with 2 keys)
- 6 Louvered back panel for hanging storage bins

UP TO
350
LBS.



ACQV4C82R



ACS4C

ACQV4P

COLORS

Textured Charcoal Gray, Textured Putty



PRODUCT HIGHLIGHTS

- **SECURE** – Lockable cabinet provides secure storage for sensitive supplies
- **NO ASSEMBLY** – Cabinets ship fully assembled
- **CAPACITY** – Secure Mini-Cabinets have 350-lb. weight capacity
- **MOUNTING** – Cabinets are wall-mountable
- **VARIETY** – Quick-View or Solid doors available. Colors include Textured Charcoal Gray, Textured Putty

AkroDrawers®

Quick-View Mini-Cabinet 19 1/4" W x 13 1/4" D x 38" H			Dimensions (In.)			Qty. of Drawers
Model No.	Description	Cabinet Color	L	W	H	
ACQV4C ACQV4P	Secure Mini-Cabinet, Quick-View Door, no AkroDrawers	Textured Charcoal Gray Textured Putty	–	–	–	–
ACQV4C42 ACQV4P42	Secure Mini-Cabinet, Quick-View Door with 31142 AkroDrawers	Textured Charcoal Gray Textured Putty	11-5/8	3-3/4	4-5/8	16
ACQV4C62 ACQV4P62	Secure Mini-Cabinet, Quick-View Door with 31162 AkroDrawers	Textured Charcoal Gray Textured Putty	11-5/8	5-9/16	4-5/8	12
ACQV4C82 ACQV4P82	Secure Mini-Cabinet, Quick-View Door with 31182 AkroDrawers	Textured Charcoal Gray Textured Putty	11-5/8	8-3/8	4-5/8	8
ACQV4CAST ACQV4PAST	Secure Mini-Cabinet, Quick-View Door with 31142, 31162 & 31182 AkroDrawers	Textured Charcoal Gray Textured Putty	See Above			4 / 6 / 2

Specify drawer color when ordering: Red, Blue, Yellow, Gray or Crystal Clear available with Gray Cabinet. Blue or Crystal Clear available with Putty Cabinet. One drawer color per unit.



Steel Door Mini-Cabinet 19 1/4" W x 13 1/4" D x 38" H			Dimensions (In.)			Qty. of Drawers
Model No.	Description	Cabinet Color	L	W	H	
ACS4C ACS4P	Secure Mini-Cabinet, Steel Door, no AkroDrawers	Textured Charcoal Gray Textured Putty	–	–	–	–
ACS4C42 ACS4P42	Secure Mini-Cabinet, Steel Door with 31142 AkroDrawers	Textured Charcoal Gray Textured Putty	11-5/8	3-3/4	4-5/8	16
ACS4C62 ACS4P62	Secure Mini-Cabinet, Steel Door with 31162 AkroDrawers	Textured Charcoal Gray Textured Putty	11-5/8	5-9/16	4-5/8	12
ACS4C82 ACS4P82	Secure Mini-Cabinet, Steel Door with 31182 AkroDrawers	Textured Charcoal Gray Textured Putty	11-5/8	8-3/8	4-5/8	8
ACS4CAST ACS4PAST	Secure Mini-Cabinet, Steel Door with 31142, 31162 & 31182 AkroDrawers	Textured Charcoal Gray Textured Putty	See Above			4 / 6 / 2

Specify drawer color when ordering: Red, Blue, Yellow, Gray or Crystal Clear available with Gray Cabinet. Blue or Crystal Clear available with Putty Cabinet. One drawer color per unit.

Cabinet Replacement Keys

Model No.	Description
ACKEY	Replacement Key. The key is stamped 1333



Stackable Cabinets

STACKABLE DRAWER STORAGE CABINETS



FEATURES

- Stacking a 12" deep cabinet on top of an 18" cabinet provides additional work space
- For secure stacking, special feet nest into recessed dimples in the tops of the cabinets
- Optional base stands provide 8 more inches of height for easier, more comfortable access to lower shelves
- Durable powder-coated finish

UP TO
120
LBS.



AD3511C82, AD3517C68, AD3517BSC



AD3511C82R



AD3517P68CRY



AD3517BSC

COLORS

Textured Charcoal Gray, Textured Putty



PRODUCT HIGHLIGHTS

- EFFICIENT** – Increased storage capacity for AkroDrawers® by providing more space to organize and color code inventory
- STACKABLE** – Units can be stacked up to 3 high
- NO ASSEMBLY** – Cabinets ship fully assembled
- CAPACITY** – Weight capacity: 120 lbs. Combined stacked weight capacity: 200 lbs.
- VARIETY** – 2 sizes and 2 colors: Textured Charcoal Gray, Textured Putty

AkroDrawers®

Stackable Cabinet 35" W x 11" D x 22" H			Bin Dimensions (In.)			Shelf Dimensions (In.)			Qty. of Drawers
Model No.	Description	Cabinet Color	L	W	H	D	L	H	
AD3511C AD3511P	Stackable Cabinet with no AkroDrawers	Textured Charcoal Gray Textured Putty	–	–	–	11	34	4-11/16	–
AD3511CAST2 AD3511PAST2	Stackable Cabinet with 31112 & 31162 AkroDrawers	Textured Charcoal Gray Textured Putty	11-5/8	11-1/8*	4-5/8	11	34	4-11/16	8 / 8
AD3511C62 AD3511P62	Stackable Cabinet with 31162 AkroDrawers	Textured Charcoal Gray Textured Putty	11-5/8	5-9/16	4-5/8	11	34	4-11/16	24
AD3511C82 AD3511P82	Stackable Cabinet with 31182 AkroDrawers	Textured Charcoal Gray Textured Putty	11-5/8	8-3/8	4-5/8	11	34	4-11/16	16

Specify drawer color when ordering: Red, Blue, Yellow, Gray or Crystal Clear available with Gray Cabinet. Blue or Crystal Clear available with Putty Cabinet. One drawer color per unit. *Width of 31112 bin.

Stackable Cabinet 35" W x 17" D x 22" H			Bin Dimensions (In.)			Shelf Dimensions (In.)			Qty. of Drawers
Model No.	Description	Cabinet Color	L	W	H	D	L	H	
AD3517C AD3517P	Stackable Cabinet with no AkroDrawers	Textured Charcoal Gray Textured Putty	–	–	–	17	34	4-11/16	–
AD3517CAST2 AD3517PAST2	Stackable Cabinet with 31118 & 31168 AkroDrawers	Textured Charcoal Gray Textured Putty	17-5/8	11-1/8*	4-5/8	17	34	4-11/16	8 / 8
AD3517C68 AD3517P68	Stackable Cabinet with 31168 AkroDrawers	Textured Charcoal Gray Textured Putty	17-5/8	5-9/16	4-5/8	17	34	4-11/16	24
AD3517C88 AD3517P88	Stackable Cabinet with 31188 AkroDrawers	Textured Charcoal Gray Textured Putty	17-5/8	8-3/8	4-5/8	17	34	4-11/16	16
AD3517CAST AD3517PAST	Stackable Cabinet with 31168 & 31188 AkroDrawers	Textured Charcoal Gray Textured Putty	See Above			17	34	4-11/16	12 / 8

Specify drawer color when ordering: Red, Blue, Yellow, Gray or Crystal Clear available with Gray Cabinet. Blue or Crystal Clear available with Putty Cabinet. One drawer color per unit. *Width of 31118 bin.

Optional Base Stands for Stackable Cabinets			Dimensions (In.)		
Model No.	Description	Base Stand Color	W	D	H
AD3511BSC AD3511BSP	Base Stand for 11" Stackable Cabinet	Textured Charcoal Gray Textured Putty	35-1/4	11-1/4	8
AD3517BSC AD3517BSP	Base Stand for 17" Stackable Cabinet	Textured Charcoal Gray Textured Putty	35-1/4	17-1/4	8

Super Modular Cabinets

STACKABLE OR WALL-MOUNTED DRAWER STORAGE CABINETS



FEATURES

- 1 For secure stacking, special feet nest into recessed dimples in the tops of the cabinets
- 2 AkroDrawers® fit snugly on each shelf so drawer is protected from dust and debris
- 3 Durable powder-coated finish



AD1811CASTCRY

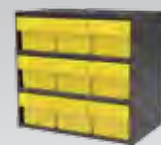

AD1811C62Y



AD1817P88B



AD2311C62R

COLORS

Textured Charcoal Gray, Textured Putty



PRODUCT HIGHLIGHTS

- **FUNCTIONAL** – Specially designed stackable or wall-mountable cabinets to organize AkroDrawers
- **STACKABLE** – Units can be stacked up to 3 high
- **WALL-MOUNTABLE** – Light assembly required for mounting of 11” cabinets
- **VERSATILE** – 11” cabinets can be hung on louvered panels or rail racks (bracket included)
- **NO ASSEMBLY** – Cabinets ship fully assembled
- **CAPACITY** – Weight capacity: 60 lbs. (18” cabinets); 75 lbs. (23” cabinets). Combined stacked weight capacity: 100 lbs.
- **VARIETY** – 3 sizes and 2 colors: Textured Charcoal Gray, Textured Putty

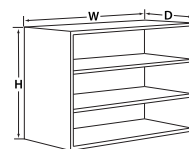

AkroDrawers®

Super Modular Cabinets 18" W x 11" D x 16½" H			Bin Dimensions (In.)			Shelf Dimensions (In.)			
Model No.	Description	Cabinet Color	L	W	H	D	L	H	Qty. of Drawers
AD1811C AD1811P	Small Cabinet with no AkroDrawers	Textured Charcoal Gray Textured Putty	–	–	–	11	17	4-19/32	–
AD1811C62 AD1811P62	Small Cabinet with 31162 AkroDrawers	Textured Charcoal Gray Textured Putty	11-5/8	5-9/16	4-5/8	11	17	4-19/32	9
AD1811C82 AD1811P82	Small Cabinet with 31182 AkroDrawers	Textured Charcoal Gray Textured Putty	11-5/8	8-3/8	4-5/8	11	17	4-19/32	6
AD1811CAST AD1811PAST	Small Cabinet with 31162 and 31182 AkroDrawers	Textured Charcoal Gray Textured Putty	See Above			11	17	4-19/32	6 / 2

Specify drawer color when ordering: Red, Blue, Yellow, Gray or Crystal Clear available with Gray Cabinet. Blue or Crystal Clear available with Putty Cabinet. One drawer color per unit.



Super Modular Cabinets 18" W x 17" D x 16½" H			Bin Dimensions (In.)			Shelf Dimensions (In.)			
Model No.	Description	Cabinet Color	L	W	H	D	L	H	Qty. of Drawers
AD1817C AD1817P	17" Deep Cabinet with no AkroDrawers	Textured Charcoal Gray Textured Putty	–	–	–	17	17	4-19/32	–
AD1817C68 AD1817P68	17" Deep Cabinet with 31168 AkroDrawers	Textured Charcoal Gray Textured Putty	17-5/8	5-9/16	4-5/8	17	17	4-19/32	9
AD1817C88 AD1817P88	17" Deep Cabinet with 31188 AkroDrawers	Textured Charcoal Gray Textured Putty	17-5/8	8-3/8	4-5/8	17	17	4-19/32	6
AD1817CAST AD1817PAST	17" Deep Cabinet with 31168 and 31188 AkroDrawers	Textured Charcoal Gray Textured Putty	See Above			17	17	4-19/32	6 / 2

Specify drawer color when ordering: Red, Blue, Yellow, Gray or Crystal Clear available with Gray Cabinet. Blue or Crystal Clear available with Putty Cabinet. One drawer color per unit.



Super Modular Cabinets 23" W x 11" D x 16½" H			Bin Dimensions (In.)			Shelf Dimensions (In.)			
Model No.	Description	Cabinet Color	L	W	H	D	L	H	Qty. of Drawers
AD2311C AD2311P	Medium Cabinet with no AkroDrawers	Textured Charcoal Gray Textured Putty	–	–	–	11	22	4-19/32	–
AD2311C62 AD2311P62	Medium Cabinet with 31162 AkroDrawers	Textured Charcoal Gray Textured Putty	11-5/8	5-9/16	4-5/8	11	22	4-19/32	12

Specify drawer color when ordering: Red, Blue, Yellow, Gray or Crystal Clear available with Gray Cabinet. Blue or Crystal Clear available with Putty Cabinet. One drawer color per unit.





Wire Shelving Components

BUILD CUSTOM SHELVING UNITS

NEW!



IMAGE INCLUDES:
 AWP74UPRIGHT . . . 4
 AWS2448SHELF . . . 1
 AWS2448SL 4
 AW2448FRAME . . . 1

COLOR
 Chrome



FEATURES

- 1 Open wire design minimizes dust accumulation and improves visibility
- 2 Constructed from steel with a chrome finish
- 3 NSF-certified
- 4 Quick-Adjust Clips lock onto shelf posts, and unlock to adjust shelves
- 5 Leveling bolts screw securely into uprights to level shelf system on uneven surfaces

PRODUCT HIGHLIGHTS

- **EFFICIENT** – Streamlines workflow and order picking
- **FUNCTIONAL** – Works with a variety of Akro-Mils storage products to organize parts and increase efficiency
- **CAPACITY** – Stationary units hold a maximum of 2,000 lbs.; mobile units with casters have a capacity of 900 lbs. Maximum weight capacity per shelf: 48" or shorter = 800 lbs.; longer than 48" = 600 lbs.
- **ASSEMBLY** – Easy, one-person set-up and installation. No tools required!
- **VARIETY** – Accessories such as ledges, mats and dividers extend the versatility of the shelves. Multiple shelf sizes available, see chart.

Wire Shelving System Components

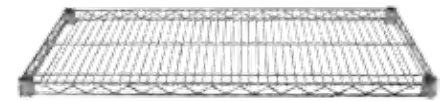

Horizontal Shelf

Wire Shelves - Chrome		
Model No.	Description	Ctn. Qty.
AWS1224SHELF	12" x 24" Horizontal Wire Shelf	4
AWS1236SHELF	12" x 36" Horizontal Wire Shelf	4
AWS1248SHELF	12" x 48" Horizontal Wire Shelf	4
AWS1436SHELF	14" x 36" Horizontal Wire Shelf	4
AWS1824SHELF	18" x 24" Horizontal Wire Shelf	4
AWS1830SHELF	18" x 30" Horizontal Wire Shelf	4
AWS1836SHELF	18" x 36" Horizontal Wire Shelf	4
AWS1848SHELF	18" x 48" Horizontal Wire Shelf	4
AWS1860SHELF	18" x 60" Horizontal Wire Shelf	2
AWS1872SHELF	18" x 72" Horizontal Wire Shelf	2
AWS2424SHELF	24" x 24" Horizontal Wire Shelf	4
AWS2436SHELF	24" x 36" Horizontal Wire Shelf	4
AWS2448SHELF	24" x 48" Horizontal Wire Shelf	4
AWS2460SHELF	24" x 60" Horizontal Wire Shelf	2
AWS2472SHELF	24" x 72" Horizontal Wire Shelf	2
AWS3648SHELF	36" x 48" Horizontal Wire Shelf	2
AWS3660SHELF	36" x 60" Horizontal Wire Shelf	2
AWS3672SHELF	36" x 72" Horizontal Wire Shelf	2



Shelf Posts

Wire Shelving Posts - Chrome		
Model No.	Description	Ctn. Qty.
AWP34UPRIGHT	34" Shelf Post	4
AWP54UPRIGHT	54" Shelf Post	4
AWP63UPRIGHT	63" Shelf Post	4
AWP74UPRIGHT	74" Shelf Post	4
AWP86UPRIGHT	86" Shelf Post	4
AWP96UPRIGHT	96" Shelf Post	4

Wire Shelving Components

BUILD CUSTOM SHELVING UNITS

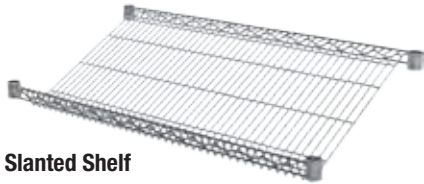

Slanted Shelf

Slanted Wire Shelves - Chrome		
Model No.	Description	Ctn. Qty.
AWS1836SL	18" x 36" Slanted Wire Shelf	4
AWS1848SL	18" x 48" Slanted Wire Shelf	4
AWS2436SL	24" x 36" Slanted Wire Shelf	4
AWS2448SL	24" x 48" Slanted Wire Shelf	4



Swivel Caster



Swivel Caster w/Brake

Caster Sets		
Model No.	Description	Pkg. Qty.
AWPCAST4	Set of 4 Casters - 2 w/Brakes 100 x 25 (4")	1
AWPCAST5	Set of 4 Casters - 2 w/Brakes 125 x 25 (5")	1



Angle•Vu™ Label Holder



Angle-Vu Model No.	Dimensions (In.)		Cards Per Sheet		Total No.	
	W	H	Cards Per Sheet	Sheets Per Pack	Cards Per Pack	Label Holders
29306	3	1-1/4	16	3	48	25

For additional information, see page 14.



3-Sided Frame

Wire Shelving Frames - Chrome		
Model No.	Description	Ctn. Qty.
AW1836FRAME	Set of 2 - 3-Sided Frame 18 x 36	2
AW1848FRAME	Set of 2 - 3-Sided Frame 18 x 48	2
AW2436FRAME	Set of 2 - 3-Sided Frame 24 x 36	2
AW2448FRAME	Set of 2 - 3-Sided Frame 24 x 48	2

*Quick-Adjust Clips included with each handle.



Leveling Feet



Steel Feet Immobilizers



"S" Hooks



Quick-Adjust Clips



Post Clamps



Donut Bumper

Wire Shelving Accessories		
Model No.	Description	Pkg. Qty.
AWFOOTLEVEL4PK	Set of 4 Leveling Steel Feet	4
AWFOOTPLATE4PK	Set of 4 Steel Feet Immobilizers	4
AWDONUT	Donut Bumper	1
AWSHOOK8PK	Set of 8 "S" Hooks	8
AWCLIP4PK	Set of 4 Quick-Adjust Clips	4
AWCLAMP2PK	Set of 2 Post Clamps	2

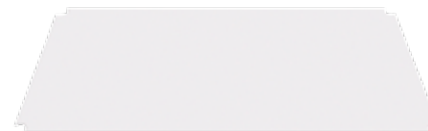

Shelf Liner Mat

Wire Shelving Shelf Liner Mats		
Model No.	Description	Ctn. Qty.
AW1224LINER	12" x 24" Shelf Liner	4
AW1236LINER	12" x 36" Shelf Liner	4
AW1248LINER	12" x 48" Shelf Liner	4
AW1824LINER	18" x 24" Shelf Liner	4
AW1836LINER	18" x 36" Shelf Liner	4
AW1848LINER	18" x 48" Shelf Liner	4
AW1860LINER	18" x 60" Shelf Liner	4
AW1872LINER	18" x 72" Shelf Liner	4
AW2424LINER	24" x 24" Shelf Liner	4
AW2436LINER	24" x 36" Shelf Liner	4
AW2448LINER	24" x 48" Shelf Liner	4
AW2460LINER	24" x 60" Shelf Liner	4
AW2472LINER	24" x 72" Shelf Liner	4
AW3660LINER	36" x 60" Shelf Liner	4
AW3672LINER	36" x 72" Shelf Liner	4

Wire Shelving Components

BUILD CUSTOM SHELVING UNITS

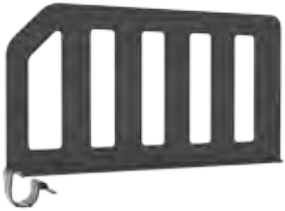

Plastic Shelf Divider

Wire/Steel Shelving Shelf Dividers - Plastic			
Model No.	Description	Installed Height	Ctn. Qty.
45612	12" Plastic Shelf Divider (Pk. of 6)	6	1
45618	18" Plastic Shelf Divider (Pk. of 6)	6	1
45624	24" Plastic Shelf Divider (Pk. of 6)	6	1

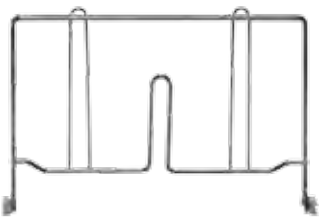

Wire Shelf Divider

Wire Shelving Shelf Dividers - Chrome			
Model No.	Description	Installed Height	Ctn. Qty.
AWDIVIDER12	12" Wire Shelf Divider	7-3/4	4
AWDIVIDER18	18" Wire Shelf Divider	7-3/4	4
AWDIVIDER24	24" Wire Shelf Divider	7-3/4	4
AWDIVIDER36	36" Wire Shelf Divider	7-3/4	4



Shelf Ledge

Side & Back Shelf Ledges - Chrome			
Model No.	Description	Installed Height	Ctn. Qty.
AWLEDGE12	12" Wire Shelf Ledge	4-5/16	4
AWLEDGE18	18" Wire Shelf Ledge	4-5/16	4
AWLEDGE24	24" Wire Shelf Ledge	4-5/16	4
AWLEDGE36	36" Wire Shelf Ledge	4-5/16	4
AWLEDGE48	48" Wire Shelf Ledge	4-5/16	4
AWLEDGE60	60" Wire Shelf Ledge	4-5/16	4
AWLEDGE72	72" Wire Shelf Ledge	4-5/16	4



Handle with Posts



Push Handle

Wire Shelving Handles - Chrome		
Model No.	Description	Ctn. Qty.
AWUHDL18	Handle with 2 Posts 18"	2
AWUHDL24	Handle with 2 Posts 24"	2
AWPHDL18*	18" Push Handle	2
AWPHDL24*	24" Push Handle	2

*Quick-Adjust Clips included with each handle.



Post-Mount Bracket



Wall-Mount Bracket

Wire Shelving Wall Mounting Brackets - Chrome		
Model No.	Description	Ctn. Qty.
AW18SPBKT*	18" Single Post Bracket	4
AW18DPBKT*	18" Double Post Bracket	4
AW24SPBKT*	24" Single Post Bracket	4
AW24DPBKT*	24" Double Post Bracket	4
AW18SWBKT	18" Single Wall Bracket	4
AW18DWBKT	18" Double Wall Bracket	4
AW24SWBKT	24" Single Wall Bracket	4
AW24DWBKT	24" Double Wall Bracket	4

Wall mounting hardware included. Wire shelves sold separately. *Posts sold separately.

Wire Shelving Starter Units

COMPLETE SHELVING UNITS



Wire Shelving 4-Shelf Starter Units come with 4 shelves, 4 posts and 8 S-Hooks for extending shelving end-to-end, back-to-back or 90 degrees. Posts include leveling feet. Make a mobile unit by adding AWPCAST4 or AWPCAST5.

AkroBin Wire Shelving Starter Units		Components		
Model No.	Description	Post Qty.	Shelf Qty.	S-Hook Qty.
AWS541224SU	Wire Shelving 54" High 12 x 24 Starter Unit	4	4	1 - 8 Pack
AWS541236SU	Wire Shelving 54" High 12 x 36 Starter Unit	4	4	1 - 8 Pack
AWS541248SU	Wire Shelving 54" High 12 x 48 Starter Unit	4	4	1 - 8 Pack
AWS541436SU	Wire Shelving 54" High 14 x 36 Starter Unit	4	4	1 - 8 Pack
AWS541824SU	Wire Shelving 54" High 18 x 24 Starter Unit	4	4	1 - 8 Pack
AWS541830SU	Wire Shelving 54" High 18 x 30 Starter Unit	4	4	1 - 8 Pack
AWS541836SU	Wire Shelving 54" High 18 x 36 Starter Unit	4	4	1 - 8 Pack
AWS541848SU	Wire Shelving 54" High 18 x 48 Starter Unit	4	4	1 - 8 Pack
AWS541860SU	Wire Shelving 54" High 18 x 60 Starter Unit	4	4	1 - 8 Pack
AWS541872SU	Wire Shelving 54" High 18 x 72 Starter Unit	4	4	1 - 8 Pack
AWS542424SU	Wire Shelving 54" High 24 x 24 Starter Unit	4	4	1 - 8 Pack
AWS542436SU	Wire Shelving 54" High 24 x 36 Starter Unit	4	4	1 - 8 Pack
AWS542448SU	Wire Shelving 54" High 24 x 48 Starter Unit	4	4	1 - 8 Pack
AWS542460SU	Wire Shelving 54" High 24 x 60 Starter Unit	4	4	1 - 8 Pack
AWS542472SU	Wire Shelving 54" High 24 x 72 Starter Unit	4	4	1 - 8 Pack
AWS543648SU	Wire Shelving 54" High 36 x 48 Starter Unit	4	4	1 - 8 Pack
AWS543660SU	Wire Shelving 54" High 36 x 60 Starter Unit	4	4	1 - 8 Pack
AWS543672SU	Wire Shelving 54" High 36 x 72 Starter Unit	4	4	1 - 8 Pack
AWS631224SU	Wire Shelving 63" High 12 x 24 Starter Unit	4	4	1 - 8 Pack
AWS631236SU	Wire Shelving 63" High 12 x 36 Starter Unit	4	4	1 - 8 Pack
AWS631248SU	Wire Shelving 63" High 12 x 48 Starter Unit	4	4	1 - 8 Pack
AWS631436SU	Wire Shelving 63" High 14 x 36 Starter Unit	4	4	1 - 8 Pack
AWS631824SU	Wire Shelving 63" High 18 x 24 Starter Unit	4	4	1 - 8 Pack
AWS631830SU	Wire Shelving 63" High 18 x 30 Starter Unit	4	4	1 - 8 Pack
AWS631836SU	Wire Shelving 63" High 18 x 36 Starter Unit	4	4	1 - 8 Pack
AWS631848SU	Wire Shelving 63" High 18 x 48 Starter Unit	4	4	1 - 8 Pack
AWS631860SU	Wire Shelving 63" High 18 x 60 Starter Unit	4	4	1 - 8 Pack
AWS631872SU	Wire Shelving 63" High 18 x 72 Starter Unit	4	4	1 - 8 Pack
AWS632424SU	Wire Shelving 63" High 24 x 24 Starter Unit	4	4	1 - 8 Pack
AWS632436SU	Wire Shelving 63" High 24 x 36 Starter Unit	4	4	1 - 8 Pack
AWS632448SU	Wire Shelving 63" High 24 x 48 Starter Unit	4	4	1 - 8 Pack
AWS632460SU	Wire Shelving 63" High 24 x 60 Starter Unit	4	4	1 - 8 Pack
AWS632472SU	Wire Shelving 63" High 24 x 72 Starter Unit	4	4	1 - 8 Pack
AWS633648SU	Wire Shelving 63" High 36 x 48 Starter Unit	4	4	1 - 8 Pack
AWS633660SU	Wire Shelving 63" High 36 x 60 Starter Unit	4	4	1 - 8 Pack
AWS633672SU	Wire Shelving 63" High 36 x 72 Starter Unit	4	4	1 - 8 Pack



36 x 48 x 54



24 x 48 x 63

Wire Shelving Starter Units

COMPLETE SHELVING UNITS



Wire Shelving 4-Shelf Starter Units come with 4 shelves, 4 posts and 8 S-Hooks for extending shelving end-to-end, back-to-back or 90 degrees. Posts include leveling feet. Make a mobile unit by adding AWPCAST4 or AWPCAST5.

AkroBin Wire Shelving Starter Units		Components		
Model No.	Description	Post Qty.	Shelf Qty.	S-Hook Qty.
AWS741224SU	Wire Shelving 74" High 12 x 24 Starter Unit	4	4	1 - 8 Pack
AWS741236SU	Wire Shelving 74" High 12 x 36 Starter Unit	4	4	1 - 8 Pack
AWS741248SU	Wire Shelving 74" High 12 x 48 Starter Unit	4	4	1 - 8 Pack
AWS741436SU	Wire Shelving 74" High 14 x 36 Starter Unit	4	4	1 - 8 Pack
AWS741824SU	Wire Shelving 74" High 18 x 24 Starter Unit	4	4	1 - 8 Pack
AWS741830SU	Wire Shelving 74" High 18 x 30 Starter Unit	4	4	1 - 8 Pack
AWS741836SU	Wire Shelving 74" High 18 x 36 Starter Unit	4	4	1 - 8 Pack
AWS741848SU	Wire Shelving 74" High 18 x 48 Starter Unit	4	4	1 - 8 Pack
AWS741860SU	Wire Shelving 74" High 18 x 60 Starter Unit	4	4	1 - 8 Pack
AWS741872SU	Wire Shelving 74" High 18 x 72 Starter Unit	4	4	1 - 8 Pack
AWS742424SU	Wire Shelving 74" High 24 x 24 Starter Unit	4	4	1 - 8 Pack
AWS742436SU	Wire Shelving 74" High 24 x 36 Starter Unit	4	4	1 - 8 Pack
AWS742448SU	Wire Shelving 74" High 24 x 48 Starter Unit	4	4	1 - 8 Pack
AWS742460SU	Wire Shelving 74" High 24 x 60 Starter Unit	4	4	1 - 8 Pack
AWS742472SU	Wire Shelving 74" High 24 x 72 Starter Unit	4	4	1 - 8 Pack
AWS743648SU	Wire Shelving 74" High 36 x 48 Starter Unit	4	4	1 - 8 Pack
AWS743660SU	Wire Shelving 74" High 36 x 60 Starter Unit	4	4	1 - 8 Pack
AWS743672SU	Wire Shelving 74" High 36 x 72 Starter Unit	4	4	1 - 8 Pack
AWS861224SU	Wire Shelving 86" High 12 x 24 Starter Unit	4	4	1 - 8 Pack
AWS861236SU	Wire Shelving 86" High 12 x 36 Starter Unit	4	4	1 - 8 Pack
AWS861248SU	Wire Shelving 86" High 12 x 48 Starter Unit	4	4	1 - 8 Pack
AWS861436SU	Wire Shelving 86" High 14 x 36 Starter Unit	4	4	1 - 8 Pack
AWS861824SU	Wire Shelving 86" High 18 x 24 Starter Unit	4	4	1 - 8 Pack
AWS861830SU	Wire Shelving 86" High 18 x 30 Starter Unit	4	4	1 - 8 Pack
AWS861836SU	Wire Shelving 86" High 18 x 36 Starter Unit	4	4	1 - 8 Pack
AWS861848SU	Wire Shelving 86" High 18 x 48 Starter Unit	4	4	1 - 8 Pack
AWS861860SU	Wire Shelving 86" High 18 x 60 Starter Unit	4	4	1 - 8 Pack
AWS861872SU	Wire Shelving 86" High 18 x 72 Starter Unit	4	4	1 - 8 Pack
AWS862424SU	Wire Shelving 86" High 24 x 24 Starter Unit	4	4	1 - 8 Pack
AWS862436SU	Wire Shelving 86" High 24 x 36 Starter Unit	4	4	1 - 8 Pack
AWS862448SU	Wire Shelving 86" High 24 x 48 Starter Unit	4	4	1 - 8 Pack
AWS862460SU	Wire Shelving 86" High 24 x 60 Starter Unit	4	4	1 - 8 Pack
AWS862472SU	Wire Shelving 86" High 24 x 72 Starter Unit	4	4	1 - 8 Pack
AWS863648SU	Wire Shelving 86" High 36 x 48 Starter Unit	4	4	1 - 8 Pack
AWS863660SU	Wire Shelving 86" High 36 x 60 Starter Unit	4	4	1 - 8 Pack
AWS863672SU	Wire Shelving 86" High 36 x 72 Starter Unit	4	4	1 - 8 Pack



18 x 48 x 74

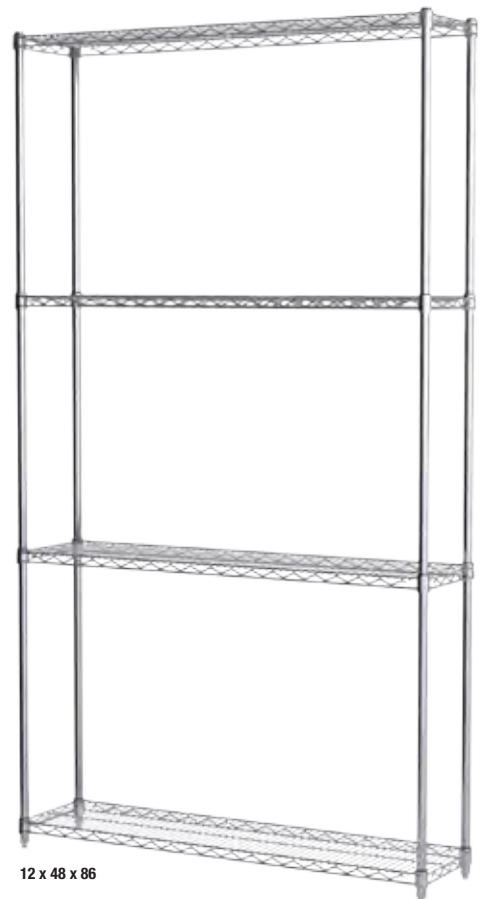

12 x 48 x 86

Wire Shelving Systems

MORE THAN 70 SYSTEM OPTIONS AVAILABLE



AWS184830260G

AkroBin Wire Shelving Systems			Bin Dimensions (In.)			Shelf Dimensions (In.)			Quantity	
Model No.	Description	AkroBin Colors	L	W	H	D	L	H	Bins	Shelves
AWS143630320	Wire Shelving w/ 30320 Bins	B, R, Y, G, S, BK, SC	8-5/8	33	5	14	36	74	12	11
AWS143630240	Wire Shelving w/ 30240 Bins	B, R, Y, G, S, BK, SC	14-3/4	8-1/4	7	14	36	74	36	4
AWS143630250	Wire Shelving w/ 30250 Bins	B, R, Y, G, S, BK, SC	14-3/4	16-1/2	7	14	36	74	18	4
AWS184830260	Wire Shelving w/ 30260 Bins	B, R, Y, G, S, BK, SC	18	11	10	18	48	74	24†	6
AWS183630265	Wire Shelving w/ 30265 Bins	B, R, Y, G, S, BK, SC	18	8-1/4	9	18	36	74	18†	5
AWS183630270	Wire Shelving w/ 30270 Bins	B, R, Y, G, S, BK, SC	18	16-1/2	11	18	36	74	9†	5
AWS244830348BE	Mobile Wire Shelving w/ 30348 Bins	BEIGE	20-1/2	8-1/4	7	24	48	74	30	6
AWS2460M30358	Mobile Wire Shelving w/ 30358 Bins	BEIGE	20-1/2	11	7	24	60	68	30	6

Bin color code: R=Red, B=Blue, Y=Yellow, G=Green, S=Stone, BK=Black, SC=Clear. Specify one bin color when ordering. †Bonus bins included.



AWS184830280R

Super-Size AkroBin Wire Shelving Systems			Bin Dimensions (In.)			Shelf Dimensions (In.)			Quantity	
Model No.	Description	Super-Size AkroBin Colors	L	W	H	D	L	H	Bins	Shelves
AWS184830280	Wire Shelving w/ 30280 Bins	R, B, Y, SC	20	12-3/8	6	18	48	74	24	9
AWS184830281	Wire Shelving w/ 30281 Bins	R, B, Y, SC	20	12-3/8	8	18	48	74	18	7
AWS184830282	Wire Shelving w/ 30282 Bins	R, B, Y, SC	20	12-3/8	12	18	48	74	12	5
AWS184830283	Wire Shelving w/ 30283 Bins	R, B, Y, SC	20	18	12	18	48	74	8	5
AWS1848SAB	Wire Shelving w/ 30280, 281, 282, 283 Bins	R, B, Y, SC	See Above			18	48	74	4/3/4/4†	6
AWS24360284	Wire Shelving w/ 30284 Bins	R, B, Y, SC	23-7/8	8-1/4	7	24	36	74	28	8
AWS24360287	Wire Shelving w/ 30287 Bins	R, B, Y, SC	23-7/8	11	10	24	36	74	16†	6
AWS24360288	Wire Shelving w/ 30288 Bins	R, B, Y, SC	23-7/8	16-1/2	11	24	36	74	12	3
AWS24360SAB	Wire Shelving w/ 30287 & 30288 Bins	R, B, Y, SC	See Above			24	36	74	12/6†	3
AWS24361288	Wire Shelving w/ 30288 Bins	R, B, Y, SC	23-7/8	16-1/2	11	24	36	63	10	3

Bin color code: R=Red, B=Blue, Y=Yellow, G=Green, S=Stone, BK=Black, SC=Clear. Specify one bin color when ordering. †Bonus bins included.



AWS183613014B

Stak-N-Store Wire Shelving Systems			Bin Dimensions (In.)			Shelf Dimensions (In.)			Quantity	
Model No.	Description	Stak-N-Store Bin Colors	L	W	H	D	L	H	Bins	Shelves
AWS184813017	Wire Shelving w/ 13017 Bins	GRY, R, B, W, SC	15-1/2	19-7/8	12-7/16	18	48	74	9	5
AWS183613014	Wire Shelving w/ 13014 Bins	GRY, R, B, SC	17-1/2	10-7/8	12-1/2	18	36	74	12	5
AWS183613018	Wire Shelving w/ 13018 Bins	GRY, R, B, SC	17-1/2	16-1/2	12-1/2	18	36	74	8	5
AWS1836SNS	Wire Shelving w/ 13014 & 13018 Bins	GRY, R, B, SC	See Above			18	36	74	8/6†	5

Bin color code: R=Red, B=Blue, W=White, GRY=Gray, SC=Clear. Specify one bin color when ordering. †Bonus bins included.



AWS143630120Y

4" Shelf Bin Wire Shelving Systems			Bin Dimensions (In.)			Shelf Dimensions (In.)			Quantity	
Model No.	Description	Shelf Bin Colors	L	W	H	D	L	H	Bins	Shelves
AWS143630120	Wire Shelving w/ 30120 Bins	R, B, Y, G, W, SC	11-5/8	4-1/8	4	14	36	74	96	12
AWS143630130	Wire Shelving w/ 30130 Bins	R, B, Y, G, W, SC	11-5/8	6-5/8	4	14	36	74	60	12
AWS143630150	Wire Shelving w/ 30150 Bins	R, B, Y, G, W, SC	11-5/8	8-3/8	4	14	36	74	48	12
AWS143630170	Wire Shelving w/ 30170 Bins	R, B, Y, G, W, SC	11-5/8	11-1/8	4	14	36	74	36	12
AWS183630128	Wire Shelving w/ 30128 Bins	R, B, Y, G, W, SC	17-7/8	4-1/8	4	18	36	74	96	12
AWS183630138	Wire Shelving w/ 30138 Bins	R, B, Y, G, W, SC	17-7/8	6-5/8	4	18	36	74	60	12
AWS183630158	Wire Shelving w/ 30158 Bins	R, B, Y, G, W, SC	17-7/8	8-3/8	4	18	36	74	48	12
AWS183630178	Wire Shelving w/ 30178 Bins	R, B, Y, G, W, SC	17-7/8	11-1/8	4	18	36	74	36	12
AWS244830124	Wire Shelving w/ 30124 Bins	R, B, Y, G, W, SC	23-5/8	4-1/8	4	24	48	74	120	12
AWS244830164	Wire Shelving w/ 30164 Bins	R, B, Y, G, W, SC	23-5/8	6-5/8	4	24	48	74	66	12
AWS244830184	Wire Shelving w/ 30184 Bins	R, B, Y, G, W, SC	23-5/8	8-3/8	4	24	48	74	60†	12
AWS244830174	Wire Shelving w/ 30174 Bins	R, B, Y, G, W, SC	23-5/8	11-1/8	4	24	48	74	48†	12

Bin color code: R=Red, B=Blue, Y=Yellow, G=Green, W=White, SC=Clear. Specify one bin color when ordering. †Bonus bins included.

Wire Shelving Systems

MORE THAN 70 SYSTEM OPTIONS AVAILABLE



AWS143630040R

6" ShelfMax Wire Shelving Systems			Bin Dimensions (In.)			Shelf Dimensions (In.)			Quantity	
Model No.	Description	ShelfMax Bin Colors	L	W	H	D	L	H	Bins	Shelves
AWS143630040	Wire Shelving w/ 30040 Bins	R, B, Y, SC	11-5/8	4-1/8	6	14	36	74	64	9
AWS143630090	Wire Shelving w/ 30090 Bins	R, B, Y, SC	11-5/8	6-5/8	6	14	36	74	40	9
AWS143630080	Wire Shelving w/ 30080 Bins	R, B, Y, SC	11-5/8	8-3/8	6	14	36	74	32	9
NEW! AWS143630010	Wire Shelving w/ 30010 Bins	R, B, Y, SC	11-5/8	11-1/8	6	14	36	74	24	9
AWS183630048	Wire Shelving w/ 30048 Bins	R, B, Y, SC	17-7/8	4-1/8	6	18	36	74	64	9
AWS183630098	Wire Shelving w/ 30098 Bins	R, B, Y, SC	17-7/8	6-5/8	6	18	36	74	40	9
AWS183630088	Wire Shelving w/ 30088 Bins	R, B, Y, SC	17-7/8	8-3/8	6	18	36	74	32	9
NEW! AWS183630018	Wire Shelving w/ 30018 Bins	R, B, Y, SC	17-7/8	11-1/8	6	18	36	74	24	9
NEW! AWS243630044	Wire Shelving w/ 30044 Bins	R, B, Y, SC	17-7/8	8-3/8	6	18	36	74	64	9
AWS243630094	Wire Shelving w/ 30094 Bins	R, B, Y, SC	23-5/8	6-5/8	6	24	36	74	40	9
NEW! AWS243630084	Wire Shelving w/ 30084 Bins	R, B, Y, SC	23-5/8	8-3/8	6	24	36	74	36‡	9
NEW! AWS243630014	Wire Shelving w/ 30014 Bins	R, B, Y, SC	23-5/8	11-1/8	6	24	36	74	24	9

Bin color code: R=Red, B=Blue, Y=Yellow, SC=Clear. Specify one bin color when ordering. ‡Bonus bins included.



AWS143630860Y

ShelfMax8 Wire Shelving Systems			Bin Dimensions (In.)			Shelf Dimensions (In.)			Quantity	
Model No.	Description	ShelfMax8 Bin Colors	L	W	H	D	L	H	Bins	Shelves
AWS143630840	Wire Shelving with 30840 Bins	R, B, Y, SC	11-5/8	4-1/8	8	14	36	74	64‡	8
AWS143630860	Wire Shelving with 30860 Bins	R, B, Y, SC	11-5/8	6-5/8	8	14	36	74	40‡	8
AWS143630880	Wire Shelving with 30880 Bins	R, B, Y, SC	11-5/8	8-2/7	8	14	36	74	32‡	8
AWS143630800	Wire Shelving with 30800 Bins	R, B, Y, SC	11-5/8	11-1/8	8	14	36	74	24‡	8
AWS183630848	Wire Shelving with 30848 Bins	R, B, Y, SC	17-5/8	4-1/8	8	18	36	74	56	8
AWS183630868	Wire Shelving with 30868 Bins	R, B, Y, SC	17-5/8	6-5/8	8	18	36	74	40‡	8
AWS183630888	Wire Shelving with 30888 Bins	R, B, Y, SC	17-5/8	8-2/7	8	18	36	74	32‡	8
AWS183630808	Wire Shelving with 30808 Bins	R, B, Y, SC	17-5/8	11-1/8	8	18	36	74	24‡	8
AWS183630818	Wire Shelving with 30818 Bins	R, B, Y, SC	17-5/8	16-1/2	8	18	36	74	16‡	8
AWS183630838	Wire Shelving with 30838 Bins	R, B, Y, SC	17-5/8	33	8	18	36	74	8‡	8
AWS243630844	Wire Shelving with 30844 Bins	R, B, Y, SC	23-5/8	4-1/8	8	24	36	74	56	8
AWS243630864	Wire Shelving with 30864 Bins	R, B, Y, SC	23-5/8	6-5/8	8	24	36	74	40‡	8
AWS243630884	Wire Shelving with 30884 Bins	R, B, Y, SC	23-5/8	8-2/7	8	24	36	74	32‡	8
AWS243630804	Wire Shelving with 30804 Bins	R, B, Y, SC	23-5/8	11-1/8	8	24	36	74	24‡	8
AWS243630814	Wire Shelving with 30814 Bins	R, B, Y, SC	23-5/8	16-1/2	8	24	36	74	16‡	8

Bin color code: R=Red, B=Blue, Y=Yellow, SC=Clear. Specify one bin color when ordering. ‡Bonus bins included.



AWS143636442B

Indicator Wire Shelving Systems			Bin Dimensions (In.)			Shelf Dimensions (In.)			Quantity	
Model No.	Description	Indicator Colors	L	W	H	D	L	H	Bins	Shelves
AWS143636442B	Wire Shelving w/ 36442 Bins	Blue/Orange	11-5/8	4-1/4	4	14	36	74	96*	12
AWS143636462B	Wire Shelving w/ 36462 Bins	Blue/Orange	11-5/8	6-3/4	4	14	36	74	60*	12
AWS183636448B	Wire Shelving w/ 36448 Bins	Blue/Orange	17-7/8	4-1/8	4	18	36	74	96*	12
AWS183636468B	Wire Shelving w/ 36468 Bins	Blue/Orange	17-7/8	6-5/8	4	18	36	74	60*	12

*Bonus Bins Included.

Wire Shelving Systems

MORE THAN 70 SYSTEM OPTIONS AVAILABLE



AWS244837608G

Straight Wall Container Wire Shelving Systems			Bin Dimensions (In.)			Shelf Dimensions (In.)			Quantity	
Model No.	Description	Container Colors	L	W	H	D	L	H	Bins	Shelves
AWS244837608	Wire Shelving w/ 37608 Containers	R, GRY	23-3/4	15-3/4	8-1/4	24	48	74	12	6

Bin color code: R=Red, GRY=Gray. Specify one bin color when ordering.



AWS2460M34240

Akro-Tub Wire Shelving Systems			Bin Dimensions (In.)			Shelf Dimensions (In.)			Quantity	
Model No.	Description	Akro-Tub Colors	L	W	H	D	L	H	Bins	Shelves
AWS1836M34301	Mobile Wire Shelving w/ 34301 Tubs	GRY	17-1/2	11	8	18	36	68	24‡	7
AWS2460M34240	Mobile Wire Shelving w/ 34240 Tubs	GRY	19	24-1/2	9-1/2	24	60	68	12	4

‡Bonus bins included.



AWS183630318R

System Bin Wire Shelving Systems			Bin Dimensions (In.)			Shelf Dimensions (In.)			Quantity	
Model No.	Description	System Bin Colors	L	W	H	D	L	H	Bins	Shelves
AWS143630312	Wire Shelving w/ 30312 Bins	R, Y, B	33	12	5	14	36	74	10	11
AWS183630318	Wire Shelving w/ 30318 Bins	R, Y, B	33	18	5	18	36	74	10	11

Bin color code: R=Red, B=Blue, Y=Yellow. Specify one bin color when ordering.



AWS246035225B

Nest & Stack Wire Shelving Systems			Bin Dimensions (In.)			Shelf Dimensions (In.)			Quantity	
Model No.	Description	Nest & Stack Tote Colors	L	W	H	D	L	H	Bins	Shelves
AWS183635180	Wire Shelving w/ 35180 Totes	B, R, GRY	18	11	6	18	36	74	30‡	9
AWS246035225	Wire Shelving w/ 35225 Totes	B, R, GRY	23-1/2	19-1/2	10	24	60	74	12	4

Lids sold separately. Bin color code: R=Red, B=Blue, GRY=Gray. Specify one bin color when ordering. ‡Bonus bins included.



AWS183633168GRY

Akro-Grid Wire Shelving Systems			Bin Dimensions (In.)			Shelf Dimensions (In.)			Quantity	
Model No.	Description	Akro-Grid Tote Colors	L	W	H	D	L	H	Bins	Shelves
AWS183633166	Wire Shelving w/ 33166 Grids	B, R, GRY	16-1/2	10-7/8	6	18	36	74	24	9
AWS183633168	Wire Shelving w/ 33168 Grids	B, R, GRY	16-1/2	10-7/8	8	18	36	74	18	7
AWS2460M33224	Mobile Wire Shelving w/ 33224 Grids	B, R, GRY	22-3/8	17-3/8	4	24	60	68	36	12

Bin color code: R=Red, B=Blue, GRY=Gray. Specify one bin color when ordering. Dividers sold separately.



Steel Shelving Systems

MORE THAN 60 SYSTEM OPTIONS AVAILABLE



FEATURES

- 1 Manufactured from high-grade, 22-gauge steel
- 2 Powder-coated finish
- 3 Quickly change shelf heights with compression clips
- 4 Adjustable shelves

PRODUCT HIGHLIGHTS

- **EFFICIENT** – Can be ordered independently or purchased with bins for a complete system
- **FUNCTIONAL** – Efficiently organize large, heavy items and improve workflow
- **VARIETY** – 5 shelf sizes available: 12" x 36", 18" x 36", 18" x 42", 24" x 36", 30" x 36"
- **CAPACITY** – Shelving units have 355 to 600 lb. weight capacity per shelf when assembled and installed per instructions. Per shelf weight capacity: 12" x 36": 500 lbs.; 18" x 36": 550 lbs.; 18" x 42": 355 lbs.; 24" x 36": 550 lbs.; 30" x 36": 600 lbs.

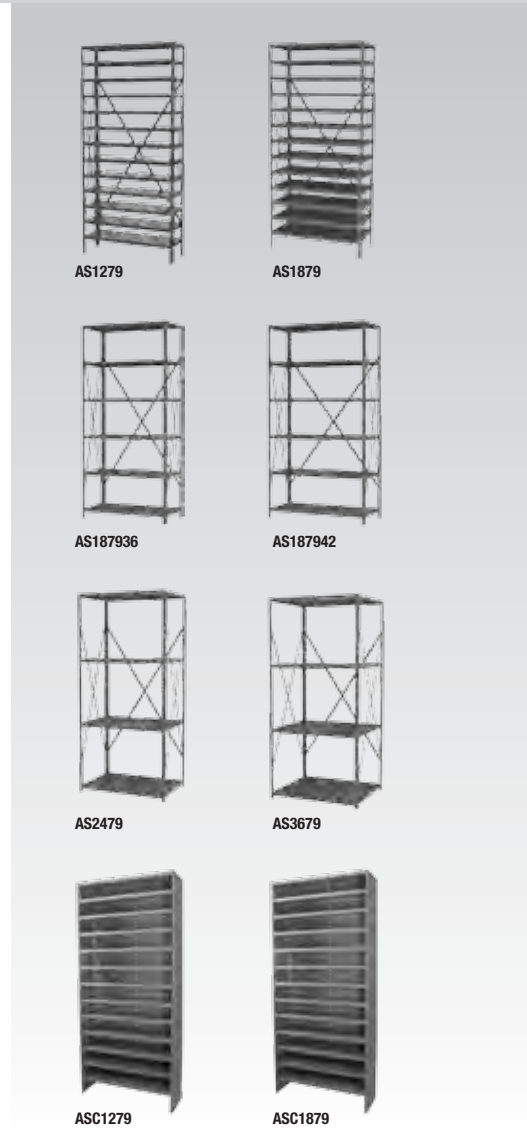

COLOR
Gray



Steel Shelving		Shelf Dimensions (In.)			Quantity
Model Number	Description	D	L	H	Shelves
ASC1279	12" Enclosed Shelving (no AkroDrawers)	12	36	79	13
ASC1879	18" Enclosed Shelving (no AkroDrawers)	18	36	79	13
AS1279	12" Shelving (no Bins)	12	36	79	13
AS1879	18" Shelving (no Bins)	18	36	79	13
AS2479	24" Shelving (no Bins)	24	36	79	4
AS3679	30" Shelving (no Bins)	30	36	79	4
AS187936	36" Shelving (no Bins)	18	36	79	6
AS187942	42" Shelving (no Bins)	18	42	79	6



ACCESSORIES



Plastic Dividers
Available in 12", 18" and 24" depths. (See page 58)

Steel Shelving Systems

MORE THAN 60 SYSTEM OPTIONS AVAILABLE



ASC1279112R

12" Enclosed Steel Shelving Systems			Bin Dimensions (In.)			Shelf Dimensions (In.)			Quantity	
Model Number	Description	AkroDrawer Colors	L	W	H	D	L	H	Drawers	Shelves
ASC1279112	Shelving with 31112 AkroDrawers	R, Y, B, GRY, CRY	11-5/8	11-1/8	4-5/8	12	36	79	36	13
ASC1279142	Shelving with 31142 AkroDrawers	R, Y, B, GRY, CRY	11-5/8	3-3/4	4-5/8	12	36	79	108	13
ASC1279162	Shelving with 31162 AkroDrawers	R, Y, B, GRY, CRY	11-5/8	5-9/16	4-5/8	12	36	79	72	13
ASC1279182	Shelving with 31182 AkroDrawers	R, Y, B, GRY, CRY	11-5/8	8-3/8	4-5/8	12	36	79	48	13
ASC1279AST	Shelving with 31142, 31162, 31182 AkroDrawers	R, Y, B, GRY, CRY	See Above			12	36	79	30 / 36 / 12 ‡	13

Drawer color code: R=Red, B=Blue, Y=Yellow, GRY=Gray, CRY=Clear. Specify drawer color when ordering. Only one color per unit. ‡Bonus drawers included.



ASC1879168B

18" Enclosed Steel Shelving Systems			Bin Dimensions (In.)			Shelf Dimensions (In.)			Quantity	
Model Number	Description	AkroDrawer Colors	L	W	H	D	L	H	Drawers	Shelves
ASC1879118	Shelving with 31118 AkroDrawers	R, Y, B, GRY, CRY	17-5/8	11-1/8	4-5/8	18	36	79	36	13
ASC1879148	Shelving with 31148 AkroDrawers	R, Y, B, GRY, CRY	17-5/8	3-3/4	4-5/8	18	36	79	108	13
ASC1879168	Shelving with 31168 AkroDrawers	R, Y, B, GRY, CRY	17-5/8	5-9/16	4-5/8	18	36	79	72	13
ASC1879188	Shelving with 31188 AkroDrawers	R, Y, B, GRY, CRY	17-5/8	8-3/8	4-5/8	18	36	79	48	13
ASC1879AST	Shelving with 31168, 31188 AkroDrawers	R, Y, B, GRY, CRY	See Above			18	36	79	36 / 24	13

Drawer color code: R=Red, B=Blue, Y=Yellow, GRY=Gray, CRY=Clear. Specify drawer color when ordering. Only one color per unit.



AS3679293R

Super-Size AkroBin Steel Shelving Systems			Bin Dimensions (In.)			Shelf Dimensions (In.)			Quantity	
Model Number	Description	Super-Size AkroBin Colors	L	W	H	D	L	H	Bins	Shelves
AS2479284	24" Shelving with 30284 Bins	B, R, Y, SC	23-7/8	8-1/4	7	24	36	79	32 ‡	9
AS2479287	24" Shelving with 30287 Bins	B, R, Y, SC	23-7/8	11	10	24	36	79	24 ‡	3
AS2479288	24" Shelving with 30288 Bins	B, R, Y, SC	23-7/8	16-1/2	11	24	36	79	12	4
AS2479ASSORT	24" Shelving with 30287/30288 Bins	B, R, Y, SC	See Above			24	36	79	12 / 6	3
AS3679292	30" Shelving with 30292 Bins	B, R, Y, SC	29-7/8	11	10	30	36	79	24	3
AS3679293	30" Shelving with 30293 Bins	B, R, Y, SC	29-7/8	16-1/2	11	30	36	79	12	4
AS3679ASSORT	30" Shelving with 30292/30293 Bins	B, R, Y, SC	See Above			30	36	79	12/6	3

Bin color code: R=Red, B=Blue, Y=Yellow, SC=Clear. Specify one bin color when ordering. ‡Bonus bins included.

Steel Shelving Systems

MORE THAN 60 SYSTEM OPTIONS AVAILABLE

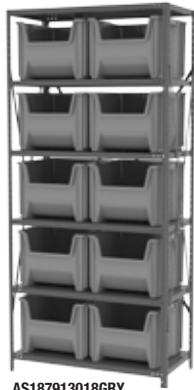

AS187913018GRY

Stak-N-Store Steel Shelving Systems			Bin Dimensions (In.)			Shelf Dimensions (In.)			Quantity	
Model Number	Description	Stak-N-Store Color	L	W	H	D	L	H	Bins	Shelves
AS187913014	36" Shelving, with 13014 Bins	B, R, GRV, SC	17-1/2	10-7/8	12-1/2	18	36	79	16‡	6
AS187913018	36" Shelving, with 13018 Bins	B, R, GRV, SC	17-1/2	16-1/2	12-1/2	18	36	79	10	6
AS1879ASORT	36" Shelving, with 13014, 13018 Bins	B, R, GRV, SC	See Above			18	36	79	8/6‡	6
AS187913017	42" Shelving, with 13017 Bins	B, R, GRV, SC, W	15-1/4	19-7/8	12-7/16	18	42	79	12‡	6

Bin color code: R=Red, B=Blue, W=White, GRV=Gray, SC=Clear. Specify one bin color when ordering. ‡Bonus bins included.



AS1879178Y

Shelf Bin Steel Shelving Systems			Bin Dimensions (In.)			Shelf Dimensions (In.)			Quantity	
Model Number	Description	Shelf Bin Colors	L	W	H	D	L	H	Bins	Shelves
AS1279110	12" Shelving with 30110 Bins	R, B, Y, G, W, SC	11-5/8	2-3/4	4	12	36	79	144	13
AS1279120	12" Shelving with 30120 Bins	R, B, Y, G, W, SC	11-5/8	4-1/8	4	12	36	79	96	13
AS1279130	12" Shelving with 30130 Bins	R, B, Y, G, W, SC	11-5/8	6-5/8	4	12	36	79	60	13
AS1279150	12" Shelving with 30150 Bins	R, B, Y, G, W, SC	11-5/8	8-3/8	4	12	36	79	48	13
AS1279170	12" Shelving with 30170 Bins	R, B, Y, G, W, SC	11-5/8	11-1/8	4	12	36	79	36	13
AS1879128	18" Shelving with 30128 Bins	R, B, Y, G, W, SC	17-7/8	4-1/8	4	18	36	79	96	13
AS1879138	18" Shelving with 30138 Bins	R, B, Y, G, W, SC	17-7/8	6-5/8	4	18	36	79	60	13
AS1879158	18" Shelving with 30158 Bins	R, B, Y, G, W, SC	17-7/8	8-3/8	4	18	36	79	48	13
AS1879178	18" Shelving with 30178 Bins	R, B, Y, G, W, SC	17-7/8	11-1/8	4	18	36	79	36	13

Bin color code: R=Red, B=Blue, Y=Yellow, G=Green, W=White, SC=Clear. Specify one bin color when ordering.



AS2479094R

ShelfMax Steel Shelving Systems			Bin Dimensions (In.)			Shelf Dimensions (In.)			Quantity	
Model Number	Description	ShelfMax Bin Colors	L	W	H	D	L	H	Bins	Shelves
AS1279040	12" Steel Shelving with 30040 Bins	R, B, Y, SC	11-5/8	4-1/8	6	12	36	79	80	11
AS1279090	12" Steel Shelving with 30090 Bins	R, B, Y, SC	11-5/8	6-5/8	6	12	36	79	50	11
AS1279080	12" Steel Shelving with 30080 Bins	R, B, Y, SC	11-5/8	8-3/8	6	12	36	79	40	11
NEW! AS1279010	12" Steel Shelving with 30010 Bins	R, B, Y, SC	11-5/8	11-1/8	6	12	36	79	32‡	11
AS1879048	18" Steel Shelving with 30048 Bins	R, B, Y, SC	17-7/8	4-1/8	6	18	36	79	80	11
AS1879098	18" Steel Shelving with 30098 Bins	R, B, Y, SC	17-7/8	6-5/8	6	18	36	79	50	11
AS1879088	18" Steel Shelving with 30088 Bins	R, B, Y, SC	17-7/8	8-3/8	6	18	36	79	40	11
NEW! AS1879018	18" Steel Shelving with 30018 Bins	R, B, Y, SC	17-7/8	11-1/8	6	18	36	79	32‡	11
NEW! AS2479044	24" Steel Shelving with 30044 Bins	R, B, Y, SC	23-5/8	4-1/8	6	24	36	79	80	11
AS2479094	24" Steel Shelving with 30094 Bins	R, B, Y, SC	23-5/8	6-5/8	6	24	36	79	50	11
NEW! AS2479084	24" Steel Shelving with 30084 Bins	R, B, Y, SC	23-5/8	8-3/8	6	24	36	79	42‡	11
NEW! AS2479014	24" Steel Shelving with 30014 Bins	R, B, Y, SC	23-5/8	11-1/8	6	24	36	79	30	11

Bin color code: R=Red, B=Blue, Y=Yellow, SC=Clear. Specify one bin color when ordering.

Steel Shelving Systems

MORE THAN 60 SYSTEM OPTIONS AVAILABLE

NEW!



AS247930804R

ShelfMax8 Steel Shelving Systems			Bin Dimensions (In.)			Shelf Dimensions (In.)			Quantity	
Model Number	Description		L	W	H	D	L	H	Bins	Shelves
AS127930840	12" Steel Shelving with 30840 Bins	R, B, Y, SC	11-5/8	4-1/8	8	12	36	79	64‡	8
AS127930860	12" Steel Shelving with 30860 Bins	R, B, Y, SC	11-5/8	6-5/8	8	12	36	79	40‡	8
AS127930880	12" Steel Shelving with 30880 Bins	R, B, Y, SC	11-5/8	8-2/7	8	12	36	79	32‡	8
AS127930800	12" Steel Shelving with 30800 Bins	R, B, Y, SC	11-5/8	11-1/8	8	12	36	79	24‡	8
AS187930848	18" Steel Shelving with 30848 Bins	R, B, Y, SC	17-7/8	4-1/8	8	12	36	79	56	8
AS187930868	18" Steel Shelving with 30868 Bins	R, B, Y, SC	17-7/8	6-5/8	8	18	36	79	40‡	8
AS187930888	18" Steel Shelving with 30888 Bins	R, B, Y, SC	17-7/8	8-2/7	8	18	36	79	32‡	8
AS187930808	18" Steel Shelving with 30808 Bins	R, B, Y, SC	17-7/8	11-1/8	8	18	36	79	24‡	8
AS187930818	18" Steel Shelving with 30818 Bins	R, B, Y, SC	17-7/8	16-1/2	8	18	36	79	16‡	8
AS187930838	18" Steel Shelving with 30838 Bins	R, B, Y, SC	17-7/8	33	8	18	36	79	8‡	8
AS247930844	24" Steel Shelving with 30844 Bins	R, B, Y, SC	23-5/8	4-1/8	8	24	36	79	56	8
AS247930864	24" Steel Shelving with 30864 Bins	R, B, Y, SC	23-5/8	6-5/8	8	24	36	79	40‡	8
AS247930884	24" Steel Shelving with 30884 Bins	R, B, Y, SC	23-5/8	8-2/7	8	24	36	79	32‡	8
AS247930804	24" Steel Shelving with 30804 Bins	R, B, Y, SC	23-5/8	11-1/8	8	24	36	79	24‡	8
AS247930814	24" Steel Shelving with 30814 Bins	R, B, Y, SC	23-5/8	16-1/2	8	24	36	79	16‡	8

Bin color code: R=Red, B=Blue, Y=Yellow, SC=Clear. Specify one bin color when ordering. ‡Bonus bins included.



AS187936448B

Indicator Bin Steel Shelving Systems			Bin Dimensions (In.)			Shelf Dimensions (In.)			Quantity	
Model Number	Description	Indicator Colors	L	W	H	D	L	H	Bins	Shelves
AS127936442B	Shelving, with 36442BLUE Indicator Bins	Blue/Orange	11-5/8	4-1/4	4	12	36	79	96	13
AS127936462B	Shelving, with 36462BLUE Indicator Bins	Blue/Orange	11-5/8	6-3/4	4	12	36	79	60	13
AS187936448B	Shelving, with 36448BLUE Indicator Bins	Blue/Orange	17-7/8	4-1/4	4	18	36	79	96	13
AS187936468B	Shelving, with 36468BLUE Indicator Bins	Blue/Orange	17-7/8	6-5/8	4	18	36	79	60	13



AS1879318Y

System Bin Steel Shelving Systems			Bin Dimensions (In.)			Shelf Dimensions (In.)			Quantity	
Model Number	Description	System Bin Color	L	W	H	D	L	H	Bins	Shelves
AS1279312	12" Shelving with System Bins	B, R, Y	33	12	5	12	36	79	10	11
AS1879318	18" Shelving with System Bins	B, R, Y	33	18	5	18	36	79	10	11

Bin color code: R=Red, B=Blue, Y=Yellow. Specify one bin color when ordering.



Dollies: Steel

HEAVY-DUTY, ALL-STEEL CONSTRUCTION



RU843HR



RD844HR



RU854HR



RD854HR

COLOR
Gray



FEATURES

- 1 Durable, powder-coated finish
- 2 All-welded 13-gauge steel or 1½" x 1½" x 1/8" angle construction
- 3 Bolt-on casters for easy replacement

PRODUCT HIGHLIGHTS

- **OPEN** – Open structural angle dollies, 1½" x 1½" x 1/8"
- **SOLID** – Solid decks are smooth, 13-gauge steel
- **LIPS UP or DOWN** – 1½" lip turned down for a smooth surface; order lips up for a contained area
- **CAPACITY** – Up to 1,000 lbs.
- **VARIETY** – 4 models, 4 sizes: 16" x 27", 18" x 24", 18" x 30", 24" x 36". Custom sizes and casters available

CASTERS & WHEELS

Caster & Wheel choices allow you to resolve problems of noise control, floor protection, impact or abrasion resistance, or load capacity. See page 91 for more caster information.

Steel Dollies

Style	Lips Down Model No.	Lips Up Model No.	Capacity (lbs.)	Caster Type	Caster Size (In.)	Deck Height Up (Inches)	Deck Height Down (Inches)
Solid Dolly	RD843HR	RU843HR	900	Polyolefin	3 x 1-1/4	5-1/2	4-1/8
Solid Dolly	RD843SS	RU843SS	1000	Steel	3 x 1-1/4	5-1/2	4-1/8
Solid Dolly	RD844HR	RU844HR	1000	Polyolefin	4 x 1-1/4	6-5/8	5-1/4
Solid Dolly	RD844SS	RU844SS	1000	Steel	4 x 1-1/4	6-5/8	5-1/4
Open Angle	RD853HR	RU853HR	900	Polyolefin	3 x 1-1/4	5-3/4	4-3/8
Open Angle	RD853SS	RU853SS	1000	Steel	3 x 1-1/4	5-3/4	4-3/8
Open Angle	RD854HR	RU854HR	1000	Polyolefin	4 x 1-1/4	6-7/8	5-1/2
Open Angle	RD854SS	RU854SS	1000	Steel	4 x 1-1/4	6-7/8	5-1/2

RHDLHOOK

Pull hook for pulling dollies; order your dolly with welded-on tow eye.

ACCESSORIES

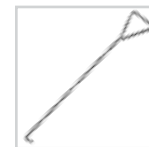

RHDLHOOK

Heavy-duty pull hook from 1/2" diameter steel for pulling dollies. Place order for a dolly with a welded-on eye.

Dollies: Steel

CUSTOM SIZES TO FIT BINS & CONTAINERS



RU843TP1721 with 30288



RU843HR1519 with 13017



RU843HR1828 with 35300



RU843HR1621 with 33226



RU843HR1420 with 39120



RU843HR1624 with 37688



Super-Size AkroBin Steel Dollies		Dimensions (In.)			Capacity/Quantity		
Model No.	Bin Compatibility	L	W	H	Casters	Ctn. Qty.	Capacity
RU843HR2018	30280, 30281, 30282 & 30283 Bins – Fits 1 wide	17-13/16	18-3/8	4-11/16	3" Polyolefin	1	900 lbs.
RU843HR2918	30290 Bins – Fits 1 wide	26-13/16	18-3/8	4-11/16	3" Polyolefin	1	900 lbs.
RU843TP2122	30286 & 30287 Bins – Fits 2 wide	20-7/8	21-7/8	4-11/16	3" Polyolefin	1	900 lbs.
RU843TP2227	30292 Bins – Fits 2 wide	21-7/8	26-7/8	4-11/16	3" Polyolefin	1	900 lbs.
RU843TP1721	30284 Bins – Fits 2 wide 30288 Bins – Fits 1 wide	16-1/2	20-7/8	4-11/16	3" Polyolefin	1	900 lbs.
RU843TP1727	30293 Bins – Fits 1 wide	16-1/2	26-7/8	4-11/16	3" Polyolefin	1	900 lbs.
RU843TP1821	30289 Bins – Fits 1 wide	18-1/2	20-7/8	4-11/16	3" Polyolefin	1	900 lbs.

Bins sold separately, see page 10.

UP TO 900 LBS.

Stak-N-Store Bin Steel Dollies		Dimensions (In.)			Capacity/Quantity		
Model No.	Bin Compatibility	L	W	H	Casters	Ctn. Qty.	Capacity
RU843HR1617	13018	16-5/8	15-3/4	4-1/2	3" Polyolefin	1	900 lbs.
RU843HR1519	13017	19-1/4	14-5/8	4-1/2	3" Polyolefin	1	900 lbs.

Bins sold separately, see page 12.

UP TO 900 LBS.

Nest & Stack Tote Steel Dollies		Dimensions (In.)			Capacity/Quantity		
Model No.	Bin Compatibility	L	W	H	Casters	Ctn. Qty.	Capacity
RU843HR1422	35240	16-5/8	15-3/4	4-1/2	3" Polyolefin	1	900 lbs.
RU843HR1822	35225, 35230	21-1/2	17-1/2	4-1/2	3" Polyolefin	1	900 lbs.
RU843HR1828	35300	27-3/8	17-3/8	4-1/2	3" Polyolefin	1	900 lbs.

Bins sold separately, see page 24.

UP TO 900 LBS.

Akro-Grid Steel Dollies		Dimensions (In.)			Capacity/Quantity		
Model No.	Bin Compatibility	L	W	H	Casters	Ctn. Qty.	Capacity
RU843HR1621	33220, 33228	21-1/8	16-1/8	5-1/8	3" Polyolefin	1	900 lbs.

Bins sold separately, see page 26.

UP TO 900 LBS.

Attached Lid Container Steel Dollies		Dimensions (In.)			Capacity/Quantity		
Model No.	Bin Compatibility	L	W	H	Casters	Ctn. Qty.	Capacity
RU843HR1420	39085, 39120, 39170, 66486CLDBL	19-7/8	14-1/4	5-1/8	3" Polyolefin	1	900 lbs.

Bins sold separately, see page 23.

UP TO 900 LBS.

Straight Wall Container Steel Dollies		Dimensions (In.)			Capacity/Quantity		
Model No.	Bin Compatibility	L	W	H	Casters	Ctn. Qty.	Capacity
RU843HR1624	37608, 37678, 37688, 37616, 37676, 37686, 37612, 37672, 37682, 38358GRY	24-3/8	16-3/8	5-1/8	3" Polyolefin	1	900 lbs.

Bins sold separately, see page 29.

UP TO 900 LBS.



Dollies: Wood

KILN-DRIED HARDWOODS PREVENT WARPING & SHRINKAGE

UP TO
1400
LBS.



FEATURES

- 1 Kiln-dried hardwood deck with countersunk bolt holes for a smooth working surface
- 2 Non-marking bolt-on 3" swivel casters with polyolefin wheels for maximum mobility
- 3 Zinc-plated rigs and hardware resist corrosion

PRODUCT HIGHLIGHTS

- **QUALITY** – All boards are cut and planed to $\frac{7}{8}$ " with guaranteed consistent quality
- **CAPACITY** – Four 3" polyolefin swivel casters offer 900 lb. weight capacity (See caster options for up to 1,400 lb. capacity)
- **VARIETY** – Dolly styles include Solid, Flush, Regular, Carpet End, Rubber Cap, All-Carpet Solid

All 3" polyolefin casters are not alike! Akro-Mils gives you more of what you paid for! See page 91.

ACCESSORIES



Wheel Locks



Tow Eye R1495

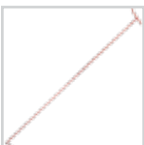

Tow Handle RTOWHANDLE
Tee-handle dolly pull hook made from $\frac{5}{16}$ " diameter steel.

Wood Dollies		Dimensions (In.)	
Model No.	Description	L	W
RD2416S3P	Solid Dolly	24	16
RD2718S3P	Solid Dolly	27	18
RD3018S3P	Solid Dolly	30	18
RD3624S3P	Solid Dolly	36	24
RD4824S3P	Solid Dolly	48	24
RD2416F3P	Flush Dolly	24	16
RD2718F3P	Flush Dolly	27	18
RD3018F3P	Flush Dolly	30	18
RD3624F3P	Flush Dolly	36	24
RD4824F3P	Flush Dolly	48	24
RD2416R3P	Regular Dolly	24	16
RD3018R3P	Regular Dolly	30	18
RD3624R3P	Regular Dolly	36	24
RD3018CE3P	Carpet End Dolly	30	18
RD3624CE3P	Carpet End Dolly	36	24
RD2718RC3P	Rubber Cap Dolly	27	18
RD3018RC3P	Rubber Cap Dolly	30	18
RD3018AC3P	All-Carpet Solid Dolly	30	18
RD3624AC3P	All-Carpet Solid Dolly	36	24



CASTERS & WHEELS

Caster & Wheel choices allow you to resolve problems of noise control, floor protection, impact or abrasion resistance, or load capacity. See page 91 for more caster information.

Caster Options		
Model No.	Description	Weight Capacity (lbs.)
3P ‡	3" Polyolefin Casters	900
4P	4" Polyolefin Casters	1200
5P	5" Polyolefin Casters	1400
3R	3" Gray Non-Marking Rubber	900
35R	3-1/2" Gray Non-Marking Rubber	900
4Rx	4" Blue Elastic Rubber	900
4R	4" Non-Marking Rubber Casters	1100
5R	5" Non-Marking Rubber Casters	1350

‡ Standard casters.

Brake Kits	
Model No.	Description
R1130BRK	3" Brake Kits for Hard Rubber Casters
R1151BRK	3" Brake Kits for Polyolefin Casters

Brake kits installed on two swivel casters – optional (non-returnable).

Dollies: Polyethylene

DURABLE INDUSTRIAL-GRADE POLYMER DOLLIES

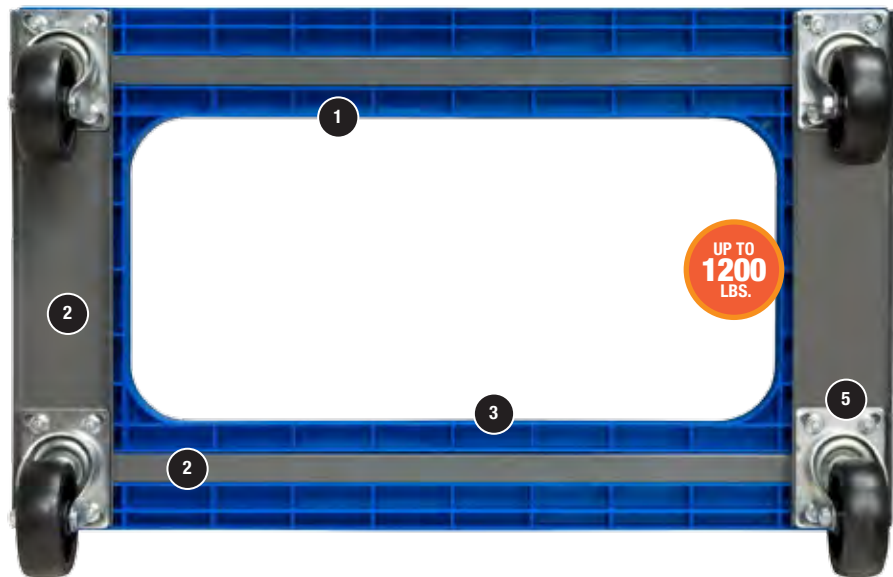

MADE IN THE USA



FEATURES

- 1 1-piece deck design
- 2 Steel-reinforced under deck
- 3 High-impact, durable polyethylene construction
- 4 Flush deck or padded models available for cargo protection
- 5 4 bolt-on swivel casters for maximum mobility

PRODUCT HIGHLIGHTS

- **QUALITY** – Easy to clean, non-porous platform will not rot, mildew or splinter
- **CAPACITY** – 1,200 lb. weight capacity
- **ASSEMBLY** – Quick, easy assembly
- **VARIETY** – 6 models, 3 colors



RMD3018RC4PN



RMD3018F4PN

COLORS
Red, Blue, Black



NEW COLOR

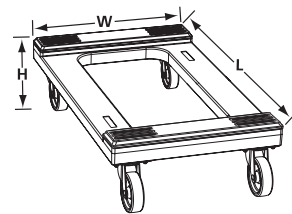

Polyethylene Dollies		Dimensions (In.)		Caster Type	Overall Height (In.)	Weight Capacity (lbs.)
Model No.	Description	L	W			
RMD3018F4PN	Flush Polyethylene w/ Casters	30	18	4" Polyolefin	6-5/8	1200
RMD3018RC4PN	Padded Polyethylene w/ Casters	30	18	4" Polyolefin	7-13/16	1200
RMD3018FN	Flush Polyethylene w/o Casters	30	18	–	1-3/8	–
RMD3018RCN	Padded Polyethylene w/o Casters	30	18	–	2-1/2	–
RMD3018F4RX	Flush Polyethylene w/ Casters	30	18	4" Blue Elastic Rubber	6-5/8	1200
RMD3018RC4RX	Padded Polyethylene w/ Casters	30	18	4" Blue Elastic Rubber	7-13/16	1200

Specify color when ordering.

CASTERS & WHEELS

Caster & Wheel choices allow you to resolve problems of noise control, floor protection, impact or abrasion resistance, or load capacity. See page 91 for more caster information.



Platform Trucks Wood Deck

FEATURING KILN-DRIED TONGUE & GROOVE HARDWOOD DECKS

How to Order Your Wood Platform Truck



SERIES 1 with Polyolefin Casters

SERIES 2 with Mold-On Casters



STEP 1

PICK A DECK SIZE

All decks are 4/4 (7/8" thick) hardwood with tongue and groove construction.

Standard deck sizes:

24" x 48" • 27" x 54" • 30" x 60" • 36" x 72"

STEP 2

PICK A DECK STYLE (1-2)

Series 1 – All Wood

- Standard with removable crossbar pipe handle at swivel end

Series 2 – Wood Deck with Steel Frame

- 2" x 2" x 1/8" all-welded steel angle frame keeps cart square (on 36" x 72" deck, 2" x 2" x 3/16")
- Heavy-duty steel frame for additional deck support
- Standard with removable crossbar pipe handle at swivel end
- The wood deck is reinforced with longitudinal stiffeners for maximum capacity. (See caster options for capacity)

STEP 3

PICK SUPERSTRUCTURE (A-D)

Superstructure



Open pipe handle

COLOR

Red



Crossbar pipe handle

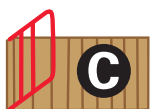
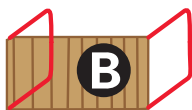

Crossbar handles are removable

STEP 4

PICK RUNNING GEARS (4-7)



Rigid caster



Swivel caster

4



Four Swivel

5



Two Rigid
Two Swivel

6



Tilt

7



Tilt Quad

STEP 5

PICK CASTER TYPE (P, M, Y, N, R, S)

Heavy-duty casters are bolted on for easy replacement. Caster options allow 1,180 to 3,000 lb. capacities.



Polyolefin

5 x 2 • 6 x 2



Mold-On Rubber

5 x 2 • 6 x 2 • 8 x 2



Polyurethane

6 x 2 • 8 x 2



Pneumatic

8 x 3 • 10 x 3 1/2



Non-Marking
Rubber

6 x 2 • 8 x 2



Steel

8 x 2

Caster & Wheel choices allow you to resolve problems of noise control, floor protection, impact or abrasion resistance, or load capacity. See page 91 for more caster and wheel information.

STEP 6

PICK CASTER SIZE – 5", 6", 8", 10"

Call your Akro-Mils distributor with your model number today to order

model #	step 1	step 2	step 3	step 4	step 5	step 6
Platform Truck	Size	Series	Super-structure	Running Gear Type	Caster Wheel	Caster Wheel Diameter
RPT	2448 2754 3060 3672	1 2	A B C D	4 5 6 7	P M Y N R S	5 6 8 10
RPT	3060	2	A	5	Y	6



Ships fully assembled & ready to use!

= RPT30602A5Y6





Platform Trucks : Steel, Super-Heavy-Duty

ADDITIONAL HEAVY-DUTY TRUCK OPTIONS

Platform Trucks – Steel Deck



FEATURES

- 1 Durable powder-coated finish
- 2 Smooth 13-gauge steel deck and frame
- 3 Steel reinforcements run lengthwise under the deck
- 4 Heavy-duty industrial casters (standard 2 swivel, 2 rigid) bolt-on for easy replacement
- 5 Removable crossbar handle

PRODUCT HIGHLIGHTS

- **HEAVY-DUTY** – 13-gauge steel deck with longitudinal steel underdeck reinforcements
- **CAPACITY** – Caster options allow 800 to 2,000 lb. capacities
- **NO ASSEMBLY** – Trucks are shipped assembled and ready to use
- **VARIETY** – Special order platform trucks are available. Select from 8 standard deck sizes and a wide variety of handle and caster options
- **DECK SIZES** – 24" x 36", 24" x 48", 24" x 60", 27" x 54", 30" x 48", 30" x 60", 36" x 60", 36" x 72"



COLOR
Gray



Platform Trucks - Steel

Model No.	Caster Type*	Caster Size (In.)	Weight Capacity (lbs.)	Deck Height (In.)
R2108FPB	Full Pneumatic	8 x 2	1200	11-1/2
R2125MRB	Mold-On Rubber	5 x 2	1200	8
R2168MRB	Mold-On Rubber	8 x 2	2000	11

* See page 91 for full description of casters and wheels.

Platform Trucks – Super-Heavy-Duty



FEATURES

- 1 Powder-coated steel frame
- 2 Super-heavy-duty kiln-dried hardwood deck
- 3 Steel C-channel and removable side rails allow for deck repair/replacement
- 4 High deck for minimal bending
- 5 Load wheels on solid 1" steel axle
- 6 Removable crossbar handle

PRODUCT HIGHLIGHTS

- **HEAVY-DUTY** – Caster options allow 1,200 to 4,000 lb. capacities
- **NO ASSEMBLY** – Trucks are shipped completely assembled and ready to use
- **VARIETY** – Deck sizes: 24" x 48", 30" x 48", 30" x 60", 36" x 72"



COLOR
Gray



ACCESSORIES

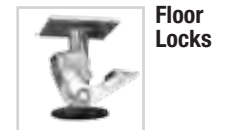

Floor Locks



Wheel Locks



Corner Bumpers



Continuous Bumpers

Platform Trucks - Super-Heavy-Duty

Model No.	Caster Type*	Caster Size (In.)	Wheel Size (In.)	Weight Capacity (lbs.)	Deck Height (In.)
R2178MRB	Mold-On Rubber	8 x 2	–	2000	12-1/4
R219885MRB	Mold-On Rubber	8 x 2	8 x 2-1/2	2500	12-1/2
R221812MRB	Mold-On Rubber	8 x 2	12 x 2-1/2	3000	16
R2258516MRB	Mold-On Rubber	8 x 2-1/2	16 x 3	4000	19-1/2

* See page 91 for full description of casters and wheels.

VERSA/Deck™

VERSATILE STRUCTURAL FOAM PLATFORM TRUCK



R90163A1411



R90110S2411



UP TO
2000
LBS.



FEATURES

- 1 More than 70 different handle/caster configurations
- 2 Non-skid structural foam deck is easy-to-clean and won't rot, chip or rust
- 3 Jam Bolts, standard on all models, hold handles in place
- 4 **NEW FEATURE!** 4 molded-in tie-down slots secure items during transport
- 5 Steel reinforcements provide durability and a weight capacity of up to 2,000 lbs.
- 6 Handles and rails feature a durable, powder-coated finish

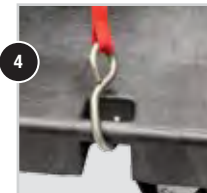

PRODUCT HIGHLIGHTS

- **DURABLE** – HDPE molded structural foam with steel reinforcement
- **CAPACITY** – Up to 2,000 lb. weight capacity
- **VARIETY** – Customizable for your exact needs with multiple handle, deck and caster options. Brake and floor lock options are available as well. Decks sizes: 24" x 48", 30" x 60"



Handle Styles:

Open Swayback



Crossbar Swayback



Open Straight



Wire Mesh Sides



High/Low



Posts



COLOR
Black/Gray



CASTER & WHEEL CHOICES

allow you to resolve problems of noise control, floor protection, impact or abrasion resistance, or load capacity. See page 91 for more information.



Mold-On Rubber



Pneumatic



Polyolefin



Polyurethane



Thermoplastic



Easy-Roll





Handle Style "A"

1 Crossbar Swayback
or
1 Open Swayback

Models ending in "11"
have open handles,
those ending in "12"
have crossbar handles

Style "A" – 1 Crossbar Swayback or 1 Open Swayback

Model No.	Deck Size	Caster Type	Caster Size (In.)
R90110A1411	24 x 48	Pneumatic	10
R90110A1412	24 x 48	Pneumatic	10
R90162A1411	24 x 48	Polyolefin	6
R90162A1412	24 x 48	Polyolefin	6
R90163A1411	24 x 48	Polyurethane	6
R90163A1412	24 x 48	Polyurethane	6
R90181A1411	24 x 48	Pneumatic	8
R90181A1412	24 x 48	Pneumatic	8
R90182A1411	24 x 48	Mold-On Rubber	8
R90182A1412	24 x 48	Mold-On Rubber	8
R90184A1411	24 x 48	Polyolefin	8
R90184A1412	24 x 48	Polyolefin	8
R90185A1411	24 x 48	Thermoplastic	8
R90185A1412	24 x 48	Thermoplastic	8
R90165A1411	24 x 48	Easy-Roll	6
R90165A1412	24 x 48	Easy-Roll	6
R90210A1011	30 x 60	Pneumatic	10
R90210A1012	30 x 60	Pneumatic	10
R90262A1011	30 x 60	Polyolefin	6
R90262A1012	30 x 60	Polyolefin	6
R90263A1011	30 x 60	Polyurethane	6
R90263A1012	30 x 60	Polyurethane	6
R90281A1011	30 x 60	Pneumatic	8
R90281A1012	30 x 60	Pneumatic	8
R90282A1011	30 x 60	Mold-On Rubber	8
R90282A1012	30 x 60	Mold-On Rubber	8
R90284A1011	30 x 60	Polyolefin	8
R90284A1012	30 x 60	Polyolefin	8
R90285A1011	30 x 60	Thermoplastic	8
R90285A1012	30 x 60	Thermoplastic	8
R90265A1011	30 x 60	Easy-Roll	6
R90265A1012	30 x 60	Easy-Roll	6

Note: Models ending in "11" have open handles, those ending in "12" have crossbar handles.



Handle Style "B"

2 Crossbar Swayback

Style "B" – 2 Crossbar Swayback

Model No.	Deck Size	Caster Type	Caster Size (In.)
R90110B2412	24 x 48	Pneumatic	10
R90181B2412	24 x 48	Pneumatic	8
R90182B2412	24 x 48	Mold-On Rubber	8
R90184B2412	24 x 48	Polyolefin	8
R90165B2412	24 x 48	Easy-Roll	6
R90210B2012	30 x 60	Pneumatic	10
R90281B2012	30 x 60	Pneumatic	8
R90282B2012	30 x 60	Mold-On Rubber	8
R90284B2012	30 x 60	Polyolefin	8
R90265B2012	30 x 60	Easy-Roll	6



Handle Style "D"

3 Open Straight



Handle Style "S"

2 Open Swayback & 4 Wire Mesh Side Panels



Handle Style "P"

1 High Side Rail & 1 Low Side Rail



Handle Style "F"

4 Corner Posts - 39" tall

Style "D" – 3 Open Straight Length of Deck

Model No.	Deck Size	Caster Type	Caster Size (In.)
R90162D3815	24 x 48	Polyolefin	6
R90163D3815	24 x 48	Polyurethane	6
R90181D3815	24 x 48	Pneumatic	8
R90182D3815	24 x 48	Mold-On Rubber	8
R90262D3015	30 x 60	Polyolefin	6
R90263D3015	30 x 60	Polyurethane	6
R90281D3015	30 x 60	Pneumatic	8
R90282D3015	30 x 60	Mold-On Rubber	8

Style "S" – 2 Open Swayback & 4 Wire Mesh Side Panels

Model No.	Deck Size	Caster Type	Caster Size (In.)
R90110S2411	24 x 48	Pneumatic	10
R90181S2411	24 x 48	Pneumatic	8
R90182S2411	24 x 48	Mold-On Rubber	8
R90184S2411	24 x 48	Polyolefin	8
R90165S2411	24 x 48	Easy-Roll	6
R90210S2011	30 x 60	Pneumatic	10
R90281S2011	30 x 60	Pneumatic	8
R90282S2011	30 x 60	Mold-On Rubber	8
R90284S2011	30 x 60	Polyolefin	8
R90265S2011	30 x 60	Easy-Roll	6

Style "P" – 1 High Side Rail & 1 Low Side Rail

Model No.	Deck Size	Caster Type	Caster Size (In.)
R90162P24111811	24 x 48	Polyolefin	6
R90163P24111811	24 x 48	Polyurethane	6
R90181P24111811	24 x 48	Pneumatic	8
R90182P24111811	24 x 48	Mold-On Rubber	8
R90262P20111011	30 x 60	Polyolefin	6
R90263P20111011	30 x 60	Polyurethane	6
R90281P20111011	30 x 60	Pneumatic	8
R90282P20111011	30 x 60	Mold-On Rubber	8

Style "F" – 4 Corner Posts

Model No.	Deck Size	Caster Type	Caster Size (In.)
R90110F44813	24 x 48	Pneumatic	10
R90163F44813	24 x 48	Polyurethane	6
R90181F44813	24 x 48	Pneumatic	8
R90182F44813	24 x 48	Mold-On Rubber	8
R90184F44813	24 x 48	Polyolefin	8
R90210F40013	30 x 60	Pneumatic	10
R90263F40013	30 x 60	Polyurethane	6
R90281F40013	30 x 60	Pneumatic	8
R90282F40013	30 x 60	Mold-On Rubber	8
R90284F40013	30 x 60	Polyolefin	8

Brake and floor lock options available – consult Akro-Mils for your application needs.



ULTRA/Deck™

HEAVY-DUTY STRUCTURAL FOAM PLATFORM TRUCK

ULTRA/Deck™



U90181A1412



FEATURES

- 1 Sturdy, easy-to-clean, non-skid structural foam deck resists most chemicals and damage from long-term weather exposure
- 2 The ULTRA/Deck is heavy-duty! Steel reinforcements and extra structural foam ribs under the deck add strength and stability for your toughest loads
- 3 Cart handles and rails feature a durable, powder-coated finish, and are removable for convenient shipping and storage

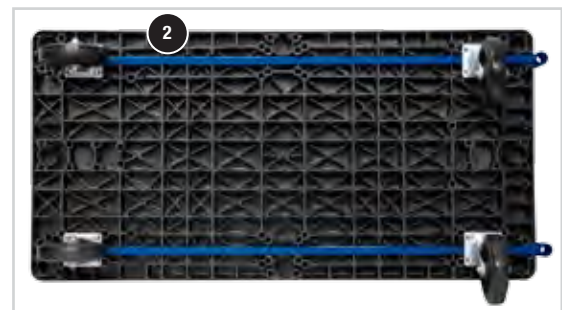

PRODUCT HIGHLIGHTS

- **RUGGED** – HDPE molded structural foam withstands the toughest loads in most environments
- **CAPACITY** – Caster options allow up to 3,000 lb. weight capacity
- **VARIETY** – Multiple handle, deck and caster options to select the exact configuration you need

Handle Styles:

Handle – Outside Deck



Open Swayback



Crossbar Swayback

Handle Rails – Indeck

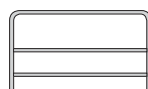

Crossbar Straight

COLOR
Black/Blue



CASTER & WHEEL CHOICES

allow you to resolve problems of noise control, floor protection, impact or abrasion resistance, or load capacity. See page 91 for more information.



Mold-On Rubber



Pneumatic



Polyolefin



Polyurethane



Thermoplastic



Easy-Roll





Handle Style "A"

1 Crossbar Swayback
or
1 Open Swayback

Models ending in "11"
have open handles,
those ending in "12"
have crossbar handles

Style "A" – 1 Crossbar Swayback or 1 Open Swayback

Model No.	Deck Size	Caster Type	Caster Size (In.)
U90110A1411	24 x 48	Pneumatic	10
U90110A1412	24 x 48	Pneumatic	10
U90162A1411	24 x 48	Polyolefin	6
U90162A1412	24 x 48	Polyolefin	6
U90163A1411	24 x 48	Polyurethane	6
U90163A1412	24 x 48	Polyurethane	6
U90181A1411	24 x 48	Pneumatic	8
U90181A1412	24 x 48	Pneumatic	8
U90182A1411	24 x 48	Mold-On Rubber	8
U90182A1412	24 x 48	Mold-On Rubber	8
U90184A1411	24 x 48	Polyolefin	8
U90184A1412	24 x 48	Polyolefin	8
U90185A1411	24 x 48	Thermoplastic	8
U90185A1412	24 x 48	Thermoplastic	8
U90165A1411	24 x 48	Easy Roll	6
U90165A1412	24 x 48	Easy Roll	6
U90210A1011	30 x 60	Pneumatic	10
U90210A1012	30 x 60	Pneumatic	10
U90262A1011	30 x 60	Polyolefin	6
U90262A1012	30 x 60	Polyolefin	6
U90263A1011	30 x 60	Polyurethane	6
U90263A1012	30 x 60	Polyurethane	6
U90281A1011	30 x 60	Pneumatic	8
U90281A1012	30 x 60	Pneumatic	8
U90282A1011	30 x 60	Mold-On Rubber	8
U90282A1012	30 x 60	Mold-On Rubber	8
U90284A1011	30 x 60	Polyolefin	8
U90284A1012	30 x 60	Polyolefin	8
U90285A1011	30 x 60	Thermoplastic	8
U90285A1012	30 x 60	Thermoplastic	8
U90265A1011	30 x 60	Easy Roll	6
U90265A1012	30 x 60	Easy Roll	6

Note: Models ending in "11" have open handles, those ending in "12" have crossbar handles.



Handle Style "B"

2 Crossbar Swayback

Style "B" – 2 Crossbar Swayback

Model No.	Deck Size	Caster Type	Caster Size (In.)
U90110B2412	24 x 48	Pneumatic	10
U90181B2412	24 x 48	Pneumatic	8
U90182B2412	24 x 48	Mold-On Rubber	8
U90184B2412	24 x 48	Polyolefin	8
U90210B2012	30 x 60	Pneumatic	10
U90281B2012	30 x 60	Pneumatic	8
U90282B2012	30 x 60	Mold-On Rubber	8
U90284B2012	30 x 60	Polyolefin	8



Handle Style "D"

3 Crossbar Straight Index

Style "D" – 3 Crossbar Straight, Index

Model No.	Deck Size	Caster Type	Caster Size (In.)
U90162D3817	24 x 48	Polyolefin	6
U90163D3817	24 x 48	Polyurethane	6
U90181D3817	24 x 48	Pneumatic	8
U90182D3817	24 x 48	Mold-On Rubber	8
U90262D3017	30 x 60	Polyolefin	6
U90263D3017	30 x 60	Polyurethane	6
U90281D3017	30 x 60	Pneumatic	8
U90282D3017	30 x 60	Mold-On Rubber	8



Handle Style "G"

2 Crossbar Straight Index;
1 Open Swayback

Style "G" – 2 Crossbar Straight, Index; 1 Open Swayback

Model No.	Deck Size	Caster Type	Caster Size (In.)
U90110G14112817	24 x 48	Pneumatic	10
U90181G14112817	24 x 48	Pneumatic	8
U90182G14112817	24 x 48	Mold-On Rubber	8
U90184G14112817	24 x 48	Polyolefin	8
U90210G10112017	30 x 60	Pneumatic	10
U90281G10112017	30 x 60	Pneumatic	8
U90282G10112017	30 x 60	Mold-On Rubber	8
U90284G10112017	30 x 60	Polyolefin	8



Handle Style "H"

1 Crossbar Straight Index;
2 Crossbar Swayback

Style "H" – 1 Crossbar Straight, Index; 2 Crossbar Swayback

Model No.	Deck Size	Caster Type	Caster Size (In.)
U90162H24121817	24 x 48	Polyolefin	6
U90163H24121817	24 x 48	Polyurethane	6
U90181H24121817	24 x 48	Pneumatic	8
U90182H24121817	24 x 48	Mold-On Rubber	8
U90262H20121017	30 x 60	Polyolefin	6
U90263H20121017	30 x 60	Polyurethane	6
U90281H20121017	30 x 60	Pneumatic	8
U90282H20121017	30 x 60	Mold-On Rubber	8



Handle Style "L"

2 Crossbar Straight Index;
2 Open Swayback

Style "L" – 2 Crossbar Straight, Index; 2 Open Swayback

Model No.	Deck Size	Caster Type	Caster Size (In.)
U90110L24112817	24 x 48	Pneumatic	10
U90163L24112817	24 x 48	Polyurethane	6
U90181L24112817	24 x 48	Pneumatic	8
U90182L24112817	24 x 48	Mold-On Rubber	8
U90184L24112817	24 x 48	Polyolefin	8
U90210L20112017	30 x 60	Pneumatic	10
U90263L20112017	30 x 60	Polyurethane	6
U90281L20112017	30 x 60	Pneumatic	8
U90282L20112017	30 x 60	Mold-On Rubber	8
U90284L20112017	30 x 60	Polyolefin	8

Other handle and caster combinations available – consult Akro-Mils for your application needs.

Platform Trucks Work Height – Heavy-Duty

TUBULAR FRAME SUPPORTS HEAVIER LOADS



FEATURES

- 1 1½" 16-gauge tubular all-welded frame
- 2 Durable powder-coated finish
- 3 Deck options: kiln-dried tongue and groove hardwood, steel, structural foam
- 4 Fixed or adjustable height deck
- 5 Optional expanded metal or solid steel shelf



RWHV24481A5M8A



RWHS30601A5M8



RWHS30601A5M8

COLOR
Red



PRODUCT HIGHLIGHTS

- **ERGONOMIC** – Height reduces strain of lifting and bending
- **DURABLE** – Hardwood, steel or structural foam decks available
- **CAPACITY** – Up to 2,000 lb. weight capacity
- **VARIETY** – Fixed and adjustable heights available. Optional expanded metal shelf or solid steel lower shelf. Deck sizes: 24" x 48", 30" x 60"

ACCESSORIES



Corner Bumpers



Expanded Metal Shelf



Solid Metal Shelf



Floor Locks



Wheel Locks

Platform Trucks - Fixed Work Height - Tubular Steel Frame		Dimensions (In.)			Caster		
Model No.	Deck Type	L	W	H	Type*	Size (In.)	Weight Capacity (lbs.)
RWH24481A5M8	Wood	24	48	26-3/8	Mold-On Rubber	8	1800
RWHV24481A5M8	Structural Foam	24	48	26-7/8	Mold-On Rubber	8	1800
RWHV24481A5Y6	Structural Foam	24	48	24-7/8	Polyurethane	6	2000
RWHS24481A5M8	Steel	24	48	25-1/4	Mold-On Rubber	8	1800
RWHS24481A5Y6	Steel	24	48	23-1/4	Polyurethane	6	1800
RWH30601A5M8	Wood	30	60	26-3/8	Mold-On Rubber	8	1800
RWHV30601A5M8	Structural Foam	30	60	26-7/8	Mold-On Rubber	8	1800
RWHV30601A5Y6	Structural Foam	30	60	24-7/8	Polyurethane	6	2000
RWHS30601A5M8	Steel	30	60	25-1/4	Mold-On Rubber	8	1800
RWHS30601A5Y6	Steel	30	60	23-1/4	Polyurethane	6	1800

* See page 91 for full description of casters and wheels.

Platform Trucks - Adjustable Work Height - Tubular Steel Frame		Dimensions (In.)			Caster		
Model No.	Deck Type	L	W	H	Type*	Size (In.)	Weight Capacity (lbs.)
RWH24481A5M8A	Wood	24	48	26-3/4 to 32-3/4	Mold-On Rubber	8	1800
RWHV24481A5M8A	Structural Foam	24	48	27-1/2 to 33-1/2	Mold-On Rubber	8	1800
RWHV24481A5Y6A	Structural Foam	24	48	25-1/2 to 31-1/2	Polyurethane	6	2000
RWHS24481A5M8A	Steel	24	48	25-5/8 to 32	Mold-On Rubber	8	1800
RWHS24481A5Y6A	Steel	24	48	23-5/8 to 32	Polyurethane	6	1800
RWH30601A5M8A	Wood	30	60	26-3/4 to 32-3/4	Mold-On Rubber	8	1800
RWHV30601A5M8A	Structural Foam	30	60	27-1/2 to 33-1/2	Mold-On Rubber	8	1800
RWHV30601A5Y6A	Structural Foam	30	60	25-1/2 to 31-1/2	Polyurethane	6	2000
RWHS30601A5M8A	Steel	30	60	25-5/8 to 32	Mold-On Rubber	8	1800
RWHS30601A5Y6A	Steel	30	60	23-5/8 to 32	Polyurethane	6	1800

* See page 91 for full description of casters and wheels.

Platform Trucks Work Height – Standard-Duty : Skids

MORE STORAGE & TRANSPORT OPTIONS



Platform Trucks Work Height

STANDARD DUTY



FEATURES

- 1 1½" x 1½" x 1/8" all-welded angle iron frame
- 2 Durable powder-coated finish
- 3 Deck options: kiln-dried tongue and groove hardwood, steel, structural foam
- 4 Fixed or adjustable height deck
- 5 Optional expanded metal or solid steel shelf

PRODUCT HIGHLIGHTS

- **ERGONOMIC** – Height reduces strain of lifting and bending
- **VARIETY** – Fixed and adjustable heights available. Optional expanded metal shelf. Deck sizes: 24" x 48", 30" x 60"

ACCESSORIES



Corner Bumpers



Floor Locks



Expanded Metal Shelf



Wheel Locks



Solid Metal Shelf



COLOR Red



Platform Trucks - Fixed Work Height - Angle Iron Frame		Dimensions (In.)			Caster		
Model No.	Deck Type	L	W	H	Type*	Size* (Inches)	Weight Capacity (lbs.)
RWH2448EA5M6	Wood	24	48	24-1/2	Mold-On Rubber	6	1500
RWHV2448EA5M6	Structural Foam	24	48	24-7/8	Mold-On Rubber	6	1500
RWHS2448EA5M6	All-Steel	24	48	22	Mold-On Rubber	6	1500
RWH3060EA5M6	Wood	30	60	24-1/2	Mold-On Rubber	6	1500
RWHV3060EA5M6	Structural Foam	30	60	24-7/8	Mold-On Rubber	6	1500
RWHS3060EA5M6	All-Steel	30	60	22	Mold-On Rubber	6	1500

* See page 91 for full description of casters and wheels.

Platform Trucks - Adjustable Work Height - Angle Iron Frame		Dimensions (In.)			Caster		
Model No.	Deck Type	L	W	H	Type*	Size* (Inches)	Weight Capacity (lbs.)
RWH2448EA5M6A	Wood	24	48	24-1/2 to 30-1/2	Mold-On Rubber	6	1500
RWHV2448EA5M6A	Structural Foam	24	48	24-7/8 to 30-7/8	Mold-On Rubber	6	1500
RWHS2448EA5M6A	All-Steel	24	48	22 to 28	Mold-On Rubber	6	1500
RWH3060EA5M6A	Wood	30	60	24-1/2 to 30-1/2	Mold-On Rubber	6	1500
RWHV3060EA5M6A	Structural Foam	30	60	24-7/8 to 30-7/8	Mold-On Rubber	6	1500
RWHS3060EA5M6A	All-Steel	30	60	22 to 28	Mold-On Rubber	6	1500

* See page 91 for full description of casters and wheels.

Semi-Live Skids

TONGUE AND GROOVE HARDWOOD DECK

UP TO 2200 LBS.



- **EFFICIENT** – Can be used with a forklift or lift jack
- **VARIETY** – Deck sizes: 24" x 48", 30" x 60" (2 wheels standard)



Semi-Live Skids - 2 Wheels		Caster		
Model No.	Description	Type*	Size (In.)	Weight Capacity (lbs.)
RA778MR	Tongue & Groove Hardwood Deck	Mold-On Rubber	8	2200
RA756MR	Tongue & Groove Hardwood Deck	Mold-On Rubber	6	1800

Lift Jacks			Caster	
Model No.	Description	Handle Style	Type*	Size (In.)
RM718MR‡	Male Lift Jack	(T) or (Loop)	Mold-On Rubber	8
RF718MR‡	Female Lift Jack	(T) or (Loop)	Mold-On Rubber	8

* See page 91 for full description of casters and wheels. ‡ - Specify Handle Style (T) or (Loop) when ordering.



Platform Trucks Series 5

ECONOMICALLY PRICED TRUCK SHIPS FLAT TO SAVE MONEY



COLOR
Gray



FEATURES

- 1 4/4 kiln-dried unfinished hardwood deck
- 2 Powder-coated 13-gauge fixed steel handle offered in open or crossbar styles

PRODUCT HIGHLIGHTS

- **DURABLE** – Kiln-dried tongue and groove unfinished hardwood deck
- **CAPACITY** – 4 caster options for up to 2,400-lb. capacity
- **UNASSEMBLED** – Cart ships unassembled, saving freight costs and warehouse space
- **DECK SIZES** – 24" x 48", 27" x 54", 30" x 60"



Series 5 Platform Trucks		Caster		
Model No.	Description	Type	Size (In.)	Weight Capacity (Lbs.)*
RPT24485J5G6GY	24 x 48, Open Handle	Polyurethane	6	2400
RPT24485K5G6GY	24 x 48, Crossbar Handle	Polyurethane	6	2400
RPT24485J5P6GY	24 x 48, Open Handle	Polyolefin	6	2100
RPT24485K5P6GY	24 x 48, Crossbar Handle	Polyolefin	6	2100
RPT24485J5N8GY	24 x 48, Open Handle	Pneumatic	8	1000
RPT24485K5N8GY	24 x 48, Crossbar Handle	Pneumatic	8	1000
RPT24485J5M8GY	24 x 48, Open Handle	Mold-On	8	1500
RPT24485K5M8GY	24 x 48, Crossbar Handle	Mold-On	8	1500
RPT27545J5G6GY	27 x 54, Open Handle	Polyurethane	6	2400
RPT27545K5G6GY	27 x 54, Crossbar Handle	Polyurethane	6	2400
RPT27545J5P6GY	27 x 54, Open Handle	Polyolefin	6	2100
RPT27545K5P6GY	27 x 54, Crossbar Handle	Polyolefin	6	2100

*Based on evenly distributed load on 4 casters. Other caster sets are available. Minimum quantities apply.

Series 5 Platform Trucks		Caster		
Model No.	Description	Type	Size (In.)	Weight Capacity (Lbs.)*
RPT27545J5N8GY	27 x 54, Open Handle	Pneumatic	8	1000
RPT27545K5N8GY	27 x 54, Crossbar Handle	Pneumatic	8	1000
RPT27545J5M8GY	27 x 54, Open Handle	Mold-On	8	1500
RPT27545K5M8GY	27 x 54, Crossbar Handle	Mold-On	8	1500
RPT30605J5G6GY	30 x 60, Open Handle	Polyurethane	6	2400
RPT30605K5G6GY	30 x 60, Crossbar Handle	Polyurethane	6	2400
RPT30605J5P6GY	30 x 60, Open Handle	Polyolefin	6	2100
RPT30605K5P6GY	30 x 60, Crossbar Handle	Polyolefin	6	2100
RPT30605J5N8GY	30 x 60, Open Handle	Pneumatic	8	1000
RPT30605K5N8GY	30 x 60, Crossbar Handle	Pneumatic	8	1000
RPT30605J5M8GY	30 x 60, Open Handle	Mold-On	8	1500
RPT30605K5M8GY	30 x 60, Crossbar Handle	Mold-On	8	1500

*Based on evenly distributed load on 4 casters. Other caster sets are available. Minimum quantities apply.

CASTER & WHEEL CHOICES

allow you to resolve problems of noise control, floor protection, impact or abrasion resistance, or load capacity. See page 91 for more information.



Mold-On Rubber



Pneumatic



Polyolefin



Polyurethane

ProCart™

VERSATILE STRUCTURAL FOAM UTILITY CART

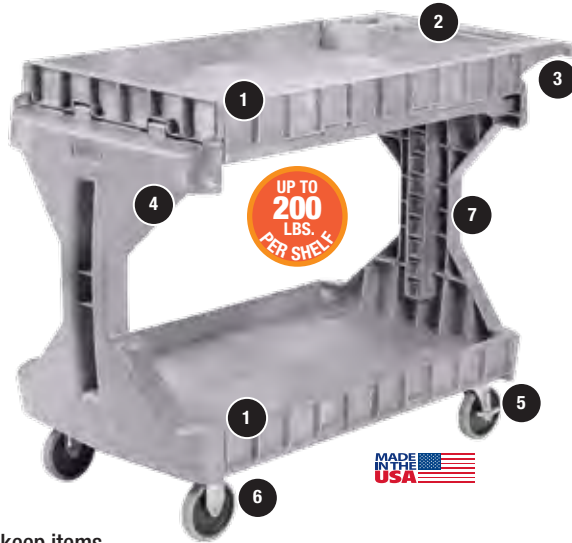

COLOR
Gray

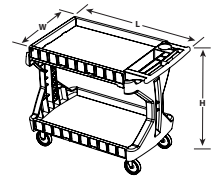

FEATURES

- 1 Hinged side gates on both shelves flip up or down to easily convert the ProCart to a flat-top or box-top cart
- 2 Deep, molded-in compartments keep items within reach (Only large cart has cup holder)
- 3 Comfortable, full-width handle gives complete handling control
- 4 Smooth, rounded corners and edges
- 5 Toe-touch, locking rear swivel wheels
- 6 Durable, non-marking, polyurethane on polyolefin 5" wheels: 1.75" x 3" caster bolt pattern
- 7 I-beam post makes loading and unloading oversized boxes on the lower shelf easy
- 8 Optional rail systems (sold separately) allow AkroBins®, Super Modular Cabinets or 19-Series Steel Cabinets to hang on cart



ProCart™

ProCart		Dimensions (In.)			Ctn. Qty.
Model No.	Description	L	W	H	
30936	Large Cart	45-5/8	24	34-3/4	1
30930	Small Cart	41-1/2	19	34-3/4	1

ProCart Rail Kits	
Model No.	Description
30900	Small Cart 9-Rail System
30906	Large Cart 9-Rail System
30902	Large Cart 2-Rail System for Super Modular Cabinets

Easy assembly – requires Phillips screwdriver and rubber mallet.

PRODUCT HIGHLIGHTS

- **VERSATILE** – All-purpose utility cart for the assembly line, warehouse or wherever you need portable storage
- **DURABLE** – High-density structural foam construction is dent-resistant, rust-proof and never needs painting
- **CAPACITY** – 400 lb. maximum cart load. 200 lb. capacity per top and bottom shelf
- **ASSEMBLY** – Light assembly required
- **VARIETY** – 2 sizes

AkroBins Ordering Information

To create a customized ProCart with AkroBins, use the chart below to determine the quantity of bins that will fit your ProCart. Carts, rail kits and bins must be ordered separately. When ordering, please specify color. See pages 4-5 for more information.

Use this chart when ordering one size AkroBins and 19-Series Cabinets for your ProCart

Bin Model No. Bin Dim. L x W x H	30210 5-3/8 x 4-1/8 x 3	30220 7-3/8 x 4-1/8 x 3	30224 10-7/8 x 4-3/16 x 4	30230 10-7/8 x 5-1/2 x 5	30234 14-3/4 x 5-1/2 x 5	30235 10-3/8 x 11 x 5	30239 10-3/4 x 8-1/4 x 7	30240 14-3/4 x 8-1/4 x 7	30250 14-3/4 x 16-1/2 x 7	30255 10-3/4 x 16-1/2 x 5	30320 8-5/8 x 33 x 5	19-Series Cabinet*
30936 Large Cart	80	80	48	36	36	18	16	16	8	12	6	4
30930 Small Cart	70	70	42	30	–	12	12	–	–	–	–	2

*Requires 98400 Suspension Straps for hanging.

RELATED PRODUCTS

Increase the benefits of your ProCart with



4-5 AkroBins



26 Akro-Grids



46 19-Series Steel Cabinets



55 Super Modular Cabinets



TiltView® Stack Cart

THE CONVENIENCE OF TILT-OUT BINS WITH A MOBILE CART

NEW!



**UP TO
250
LBS.**



FEATURES

- 1 Handles located at each cart end for transport convenience
- 2 Fully assembled cart includes 3-Bin, 4-Bin and 5-Bin TiltView cabinets
- 3 Quiet, 3" non-marking thermo-plastic rubber swivel casters with total lock brakes
- 4 Padded corner bumpers to protect walls and doorways from damage

PRODUCT HIGHLIGHTS

- **DURABLE** – Carts made of 16-gauge powder-coated steel
- **CAPACITY** – 250-lb. weight capacity (100 lbs. each side; 50 lbs. top)



TiltView Stack Cart			Dimensions (In.)			Total Bin Cups
Model No.	Description	Cart Color	L	W	H	
TVSTACKART	Cart with (2) 3 bin, (4) 4-bin and (2) 5-bin TiltView Cabinets	Beige	25-1/2	18-1/2	39-1/2	32

COLOR
Beige



TiltView Bins		Dimensions (In.)			Dividers
Model No.	Description	L	W	H	
06703	3-Bin TiltView	7-7/8	23-5/8	9-7/16	40703 (3/Pk)
06704	4-Bin TiltView	6-3/4	23-5/8	8-3/16	40704 (4/Pk)
06705	5-Bin TiltView	5-3/8	23-5/8	6-1/2	-

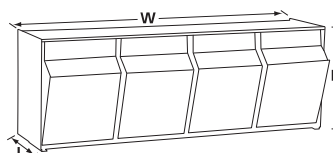

Louvered Carts

MOBILE WORKSTATION ACCOMMODATES AKRODRAWERS® & AKROBINS®



UP TO 800 LBS.



COLORS
Textured Charcoal Gray, Textured Putty



FEATURES

- 1 Welded steel frame
- 2 Tubular push handle featured on end of carts for easy handling
- 3 Louvered panels on cart end accommodate various sizes of AkroBins
- 4 Steel-reinforced butcher block work surface
- 5 Raised barriers near shelf edges keep AkroDrawers from sliding out when cart is in motion
- 6 2 rigid casters, 2 swivel casters with total lock brakes



PRODUCT HIGHLIGHTS

- **VERSATILE** – Industrial-grade mobile workstation
- **DURABLE** – Made from 16-gauge steel with a durable powder-coated finish
- **CAPACITY** – Non-marking blue elastic rubber casters allow a weight capacity of 800 lbs.
- **NO ASSEMBLY** – Ships fully assembled and ready to use
- **VARIETY** – 2 worktop sizes: 48" L x 24" W, and 36" L x 18" W. Colors: Textured Charcoal Gray, Textured Putty

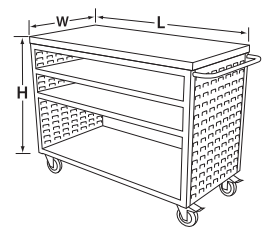

Small Louvered Cart 37" L x 18" W x 36" H			Capacity/Qty.		
Model No.	Description	Cart Color	Wt. Capacity (lbs.)	Qty. of Drawers	Drawer Color
MA3618C MA3618P	Small Louvered Cart with no AkroDrawers	Textured Charcoal Gray Textured Putty	800	–	–
MA3618C1 MA3618P1	Small Louvered Cart with 31118 AkroDrawers	Textured Charcoal Gray Textured Putty	800	6	R,B,Y,GRY,CRY B,CRY
MA3618CAST MA3618PAST	Small Louvered Cart with 31168 & 31188 AkroDrawers	Textured Charcoal Gray Textured Putty	800	12 / 4	R,B,Y,GRY,CRY B,CRY

Specify drawer color when ordering: Red, Blue, Yellow, Gray or Crystal Clear available with Gray Cart. Blue or Crystal Clear available with Putty Cart. Only one color per unit.

Large Louvered Cart 49" L x 24" W x 37½" H			Capacity/Qty.		
Model No.	Description	Cart Color	Wt. Capacity (lbs.)	Qty. of Drawers	Drawer Color
MA4824C MA4824P	Large Louvered Cart with no AkroDrawers	Textured Charcoal Gray Textured Putty	800	–	–
MA4824C1 MA4824P1	Large Louvered Cart with 31142 & 31162 AkroDrawers	Textured Charcoal Gray Textured Putty	800	22 / 16	R,B,Y,GRY,CRY B,CRY
MA4824C2 MA4824P2	Large Louvered Cart with 31142 & 31182 AkroDrawers	Textured Charcoal Gray Textured Putty	800	22 / 10	R,B,Y,GRY,CRY B,CRY
MA4824C3 MA4824P3	Large Louvered Cart with 31112 AkroDrawers	Textured Charcoal Gray Textured Putty	800	16	R,B,Y,GRY,CRY B,CRY

Specify drawer color when ordering: Red, Blue, Yellow, Gray or Crystal Clear available with Gray Cart. Blue or Crystal Clear available with Putty Cart. Only one color per unit.

AkroDrawers Model No.	Outside Dimensions (In.)		
	L	W	H
31142	11-5/8	3-3/4	4-5/8
31148	17-5/8	3-3/4	4-5/8
31162	11-5/8	5-9/16	4-5/8
31182	11-5/8	8-3/8	4-5/8
31164	23-7/8	5-9/16	4-5/8
31168	17-5/8	5-9/16	4-5/8
31188	17-5/8	8-3/8	4-5/8
31112	11-5/8	11-1/8	4-5/8
31118	17-5/8	11-1/8	4-5/8



Shelf Carts

HEAVY-DUTY CARTS ARE DESIGNED FOR DAILY WORK



UP TO
2200
LBS.



Shelf Options



Lips Down - standard



Lips Up - add "LU" to end of Model No.



FEATURES

- 1 Heavy-duty, 13-gauge welded steel frame and shelves
- 2 Models feature 1½" lips down shelves
- 3 Variety of bolt-on casters available
- 4 Swayback, vertical and horizontal tubular push handles availables

PRODUCT HIGHLIGHTS

- **DURABLE** – Made from 13-gauge steel with a durable powder-coated finish
- **CAPACITY** – Built to withstand loads up to 2,200 lbs. with recommended casters
- **NO ASSEMBLY** – Ships fully assembled and ready to use
- **VARIETY** – Cart sizes: 24" x 36", 24" x 48", 30" x 48", 30" x 60". Choose from several caster options as well as rubber matting, a writing shelf and drawers

COLOR
Gray



ACCESSORIES



Drawer



Writing Shelf



Rubber Matting



Wheel Locks

Handle Options



Swayback



Horizontal Tubular



Vertical

Shelf Carts						
Model No. Lips Down*	Height (In.)	No. of Shelves	Shelf Clearance (In.)	Caster	Handle Style	Weight Capacity (lbs.)
R1S8FP2	33-1/2	2	20-3/4	8" Full Pneumatic	Swayback	1200
R1S10FP2	35-1/4	2	20-3/4	10" Full Pneumatic	Swayback	1200
R1S5HR	30	2	20-3/4	5" x 2" Polyolefin	Vertical	1800
R1S5HR2LD	25	2	15-1/2	5" x 2" Polyolefin	Swayback	1800
R1S8MR	33	2	20-3/4	8" x 2" Mold-On Rubber	Vertical	2200
R1S8MR2	33	2	20-3/4	8" x 2" Mold-On Rubber	Swayback	2200
R2S5HR	30	2	20-3/4	5" x 2" Polyolefin	Horiz. Tubular	1800
R3S5HR	30	3	9-5/8	5" x 2" Polyolefin	Horiz. Tubular	1800
R4S5HR	63-1/4	4	17	5" x 2" Polyolefin	Horiz. Tubular	1800
R4S8MR	66-1/4	4	17	8" x 2" Mold-On Rubber	Horiz. Tubular	2200
R5S5HR	63-1/4	5	12-1/2	5" x 2" Polyolefin	Horiz. Tubular	1800
R5S8MR	66-1/4	5	12-1/2	8" x 2" Mold-On Rubber	Horiz. Tubular	2200

Specify shelf size and lips up or lips down when ordering. *Standard shelves are lips down, to order lips up, add "LU" to the end of the Model Number.



SystemBins™

System Bin Multi-Shelf Carts	Dimensions (In.)			No. of Shelves	Caster	Handle (In.)	Bin/Qty.	Color	Weight Capacity (lbs.)
	L	W	H						
R5SY5HR2436	36	24-1/2	40	5	5" x 2" Polyolefin	Horiz. Tubular	30312 / 10*	R, Y, B	1800
R5SY8MR2436	36	24-1/2	43	5	8" x 2" Mold-On Rubber	Horiz. Tubular	30312 / 10*	R, Y, B	2200
R5SY5HR3636	36	36-1/2	40	5	5" x 2" Polyolefin	Horiz. Tubular	30318 / 10**	R, Y, B	1800
R5SY8MR3636	36	36-1/2	43	5	8" x 2" Mold-On Rubber	Horiz. Tubular	30318 / 10**	R, Y, B	2200

Bin color code: R=Red, B=Blue, Y=Yellow. Specify bin color when ordering. *Qty. of 30312 System Bins included. **Qty. of 30318 System Bins included.



Box Trucks : Tray Service Carts : Super-Size AkroBin® Carts

HEAVY-DUTY MOBILE CARTS FOR HEAVY, BULKY ITEMS



Box Trucks



UP TO 1800 LBS.



- DURABLE** – Made from 13-gauge all-welded steel with 2" hemmed edges or #13 expanded metal in 1½" x 1½" x 1/8" angle frame
- CAPACITY** – 1,800 lb. weight capacity. Steel Box dimensions: 30½" overall height, 24" interior depth; Expanded Metal Box dimensions: 31½" overall height, 25" interior depth
- CASTERS** – All box trucks have 2 swivel, 2 rigid, 5" x 2" polyolefin casters (additional caster types available)
- SECURE** – Lids can be secured with padlock or combination lock
- VARIETY** – Solid steel or expanded metal sides available. Box sizes: 24" x 36", 24" x 48", 30" x 36", 30" x 48". Available with optional lid



CASTERS & WHEELS
Caster & Wheel choices allow you to resolve problems of noise control, floor protection, impact or abrasion resistance, or load capacity. See page 91 for more caster information.

COLOR
Gray



Box Trucks				
Model No.	Description	Caster Type	Weight Capacity (lbs.)	
R1B5HR	Solid Steel Box Truck	5" Polyolefin	1800	
R1B5HRL	Solid Steel Box Truck with Lid	5" Polyolefin	1800	
R1B5HRX	Expanded Metal Box Truck	5" Polyolefin	1800	
R1B5HRXL	Expanded Metal Box Truck with Lid	5" Polyolefin	1800	

Tray Service Cart



UP TO 2200 LBS.



- EFFICIENT** – Excellent for library, manufacturing and food service operations
- DURABLE** – 13-gauge all-welded steel construction features 12" deep tray and 12½" clear shelf spacing with 1½" lip
- CASTERS** – 2 swivel, 2 fixed
- HANDLE** – Tubular push handle for easy handling
- VARIETY** – Standard sizes include 18" x 30", 24" x 36", 24" x 48"; optional size: 18" x 36"

COLOR
Gray



Tray Service Cart	Dimensions (In.)			Casters	Weight Capacity (lbs.)
	Model No.	L	W		
R2T5HR1830	18	30	32-1/2	5" Polyolefin	1800
R2T5HR2436	24	36	32-1/2	5" Polyolefin	1800
R2T5HR2448	24	48	32-1/2	5" Polyolefin	1800
R2T8MR2448	24	48	35-1/2	8" Mold-On Rubber	2200

Super-Size AkroBin® Carts



UP TO 1500 LBS.



R214CS1878 shown with RSSAKBINHDDWN12

COLOR
Gray



- MOBILE** – Mobilize your Super-Size AkroBins
- EFFICIENT** – Easy organization of bulky parts
- DURABLE** – Made from 11-gauge steel
- CAPACITY** – Heavy-duty frames with weight capacities from 900 to 1,500 lbs.
- VARIETY** – 4, 6, 9, 12 and 16-bin configurations (Super-Size AkroBins sold separately). Carts have 5" x 2" polyolefin casters. Optional security bar locks bins in place

Super-Size AkroBin Steel Carts		Dimensions (In.)			No. of Handles	Accessories		Capacity/Qty.	
Model No.	Bin Compatibility	L	W	H		Security Bar	Capacity (lbs.)	Ctn. Qty.	
R214CS1841	Six 30283 Bins	41	18	48	2	RSSAKBINHDDWN6	900	1	
R214CS1859	Nine 30283 Bins	59	18	48	2	RSSAKBINHDDWN9	1350	1	
R214CS1878	Twelve 30283 Bins	78	18	48	2	RSSAKBINHDDWN12	1500	1	
R214CS2841	Six 30290 Bins	41	27-1/2	48	2	RSSAKBINHDDWN6	900	1	
R214CS2859	Nine 30290 Bins	59	27-1/2	48	2	RSSAKBINHDDWN9	1350	1	
R214CS2878	Twelve 30290 Bins	78	27-1/2	48	2	RSSAKBINHDDWN12	1500	1	
R216CS2236	Sixteen 30284 Bins or six 30286 Bins or six 30287 Bins or four 30288 Bins	35-1/2	22-1/8	35	1	–	900	1	
R216CS2836	Six 30292 Bins or four 30293 Bins	35-1/2	28-1/8	35	1	–	900	1	
R216CS2239	Four 30289 Bins	35-1/2	22-1/8	39	1	–	900	1	

Optional security bar available for all sizes. Bins sold separately.

Portable Tables & Carts : Mobile Work Tables

VERSATILE MOBILE SYSTEMS & WORK CENTERS

Portable Tables & Carts



- **VERSATILE** – Carts are ideal for stock picking, assembly operations or other heavy-duty tasks
- **DURABLE** – All-welded, 16-gauge steel construction. Gray powder-coated finish. Angle posts for added strength. Ships fully assembled!
- **CASTERS** – Non-marking thermo-plastic 5" x 1 1/4" soft rubber casters for quiet and smooth maneuverability
- **DRAWER** – High-quality storage drawer is padlock-ready
- **VARIETY** – 2 sizes. Optional drawer, writing shelf, rubber shelf matting or wheel locks are available (sold separately)

Portable Tables							
Model No.	Cart Size (In.)	Height (In.)	No. of Shelves	Shelf Clearance (In.)	Caster	Handle Style	Weight Capacity (lbs.)
RMD2ST5SR	24 x 36	36	2	27	2 Swivel / 2 Rigid	Tubular	800
RMD3ST5SR	24 x 36	36	3	12-1/2	2 Swivel / 2 Rigid	Tubular	800



RMD2ST5SR



COLOR
Gray



Mobile Work Tables – Heavy-Duty



- **MULTI-SHELF** – Includes 21" D x 36" W bottom shelf; 13 1/2" D x 37" W tilted shelf for easy access to bins
- **DURABLE** – Industrial-grade mobile workstation with a welded-steel frame and steel-reinforced premium oak top. Gray powder-coated finish. Ships fully assembled!
- **ADJUSTABLE** – 24" L x 48" W work area with 9 adjustable height settings from 36" to 48"
- **WOOD TOP** – Kiln-dried hardwood work surface extends 2" to accommodate vise or clamps; wood top is premium oak boards with rounded edges 2 1/4" in overall thickness; individual planks are 1 1/8" (5/4); optional butcher block top available
- **CASTERS** – 5" x 2" bolted-on polyurethane casters; 2 rigid, 2 swivel with total lock brakes

Mobile Work Tables - Heavy-Duty		Dimensions (In.)			Caster		
Model No.	Deck Type	L	W	H	Type	Size (In.)	Weight Capacity (lbs.)
RHWB2448P5PY0G	Oak Hardwood	24	48	36 to 48	Polyurethane	5 x 2	800

COLOR
Gray



RHWB2448P5PY0



Mobile Work Tables – Medium-Duty



- **DURABLE** – Industrial-grade mobile workstation with a welded-steel frame and steel-reinforced tongue and groove hardwood top. Gray powder-coated finish. Ships fully assembled!
- **CASTERS** – 2 bolted-on non-marking thermo-plastic soft rubber casters; 2 swivel 5" x 1 1/4" casters with total lock brakes
- **DRAWERS** – 2 padlock-ready steel drawers: 15 3/4" W x 6 3/4" H x 20" D

Mobile Work Tables - Medium-Duty		Dimensions (In.)			Caster		
Model No.	Deck Type	L	W	H	Type	Size (In.)	Weight Capacity (lbs.)
RMWB24485SRTPG	Hardwood	24	48	36	Thermoplastic	5 x 1-1/4	800

COLOR
Gray



UP TO
800
LBS.



RMWB24485SRTP



Heavy-Duty Work Benches

ADJUSTABLE & FIXED WORK HEIGHTS



FEATURES

- 1 11-gauge steel work surface extends 1½" on front and sides to accommodate a vise or clamps (hardwood extends 2')
- 2 Wraparound steel backstop keeps items from falling behind work bench
- 3 Adjustable work height telescoping C-channel legs provide a range of work heights from 30" to 40" (1½" increments)
- 4 12-gauge welded steel shelves
- 5 13½" deep middle shelf is sloped for easy access to bins or containers
- 6 Anchor pads on each leg secure bench in a fixed position
- 7 Durable powder-coated finish

PRODUCT HIGHLIGHTS

- **DURABLE** – Heavy-duty steel frame work bench. Gray powder-coated finish.
- **VARIETY** – Bench sizes: 30" x 60" and 30" x 72". Fixed or adjustable work heights. Steel, kiln-dried premium hardwood, butcher block or composition work surface. Work surface thickness: wood 2¼"; butcher block 1¾"; composition 1¾"



How to Order Your Work Bench

STEP 1

PICK A SIZE

Standard work table sizes:
30" x 60" • 30" x 72"

STEP 2

PICK FRAME COLOR (G)

Standard color:
Gray

STEP 3

PICK HEIGHT STYLE (F, A)

Fixed Height:
34" high

Adjustable Height:
30" - 40" high

STEP 4

PICK SHELF OPTIONS (1, 2, 3, 4)

- Option 1:**
Both shelves FORWARD, toward the front of the bench
- Option 2:**
Both shelves BACK, toward the back of the bench
- Option 3:**
Middle shelf FORWARD, bottom shelf BACK
- Option 4:**
Middle shelf BACK, bottom shelf FORWARD

STEP 4

PICK WORK SURFACE (S, P, B, C)

- Steel (S):**
11-gauge steel
- Hardwood (P):**
Premium kiln-dried hardwood 2¼" thick
- Butcher Block (B):**
1¾"
- Composition (C):**
1¾"

Call your Akro-Mils distributor with your model number today to order

model #	step 1	step 2	step 3	step 4	step 5
H-D Work Bench	Size	Frame Color	Height Style	Shelf Options	Work Surface
RHWB	3060	G	F (Fixed)	1 (Both shelves forward)	S (Steel)
	3072	(Gray)	A (Adjustable)	2 (Both shelves back)	P (Hardwood)
				3 (Middle fwd, Bottom back)	B (Butcher Block)
				4 (Middle back, Bottom fwd)	C (Composition)
RHWB	3060	G	F	3	B
= RHWB3060GF3B					

Ships fully assembled & ready to use!





Hand Trucks

HEAVY-DUTY : MEDIUM-DUTY : GAS : CYLINDER



Heavy-Duty Hand Trucks

- **HEAVY-DUTY** – Hand trucks ideal for all types of loads
- **FRAME** – 1" OD structural pipe frame, 13-gauge steel
- **NOSE PLATE** – Standard 8" x 14" size. Optional 10" x 14" or 14" x 14" nose plate available, 7-gauge steel
- **WHEELS** – Two-position bracket fits 8" or 10" wheels
- **HANDLES** – Flow Back or Dual Loop handles



Medium-Duty Hand Trucks

- **FUNCTIONAL** – Hand trucks for day-to-day tasks
- **DURABLE** – Heavy-flat bar and tube for climbing stairs
- **FRAME** – 7/8" OD structural pipe frame, 13-gauge wall
- **NOSE PLATE** – Standard 7" x 14" size, 7-gauge steel
- **WHEELS** – Two-position bracket fits 8" or 10" wheels



4-Wheel Gas Cylinder Trucks

- **HEAVY-DUTY** – Designed to handle 330 cu. ft. cylinders
- **FRAME** – 1" OD structural pipe frame, 13-gauge wall
- **NOSE PLATE** – Standard 7" x 14" size, 7-gauge steel
- **WHEELS** – 4" polyolefin swivel casters



Standard Gas Cylinder Trucks

- **MEDIUM-DUTY** – Perfect for medium to large cylinders
- **VERSATILE** – Transports boxes or other bulky items
- **FUNCTIONAL** – Includes heavy-duty holding chain

COLOR
Gray



Heavy-Duty Hand Trucks - Flow Back			Dimensions (In.)	
Model No.	Wheel Type	Wheel Size (In.)	H	W
R4008MR	Mold-On Rubber	8	45	19-3/4
R4008MR2	Mold-On Rubber	8	52	19-3/4
R4010FP	Full Pneumatic	10	45	22
R4010FP2	Full Pneumatic	10	52	22
R4010SP	Semi-Pneumatic	10	45	20
R4010SP2	Semi-Pneumatic	10	52	22

Heavy-Duty Hand Trucks - Dual Loop			Dimensions (In.)	
Model No.	Wheel Type	Wheel Size (In.)	H	W
R4510SP	Semi-Pneumatic	10	46	20
R4510SP2	Semi-Pneumatic	10	53	20

COLOR
Gray



Medium-Duty Hand Trucks - Flow Back			Dimensions (In.)	
Model No.	Wheel Type	Wheel Size (In.)	H	W
R3008MR	Mold-On Rubber	8	45	19-5/8
R3010FP	Full Pneumatic	10	45	22
R3010SP	Semi-Pneumatic	10	45	20

COLOR
Green



4-Wheel Gas Cylinder Trucks				
Model No.	Truck Type	Wheel Type	Wheel Size (In.)	Base Plate
RGTS10FP	Single	Full Pneumatic	10 x 3-1/2	14" W x 6" D, OAH – 45" 1143
RGTD10FP	Dual	Full Pneumatic	10 x 3-1/2	29" W x 6" D, OAH – 45" 1143
RGTS10SP	Single	Semi-Pneumatic	10 x 2-3/4	14" W x 6" D, OAH – 45" 1143
RGTD10SP	Dual	Semi-Pneumatic	10 x 2-3/4	29" W x 6" D, OAH – 45" 1143

COLOR
Green



Standard Gas Cylinder Trucks				
Model No.	Description	Wheel Type	Wheel Size (In.)	Base Plate
RCT40LW	Dual with T-Handle	Plain Bore Plastic	8 x 1-3/4	17" W x 8" D, OAH – 43" 1092
RCTV40SP	Single	Semi-Pneumatic	10 x 2-3/4	14" W x 7" D, OAH – 48" 1219



Flow Back Handle (FB)



Dual Loop Handle



T-Handle

Dual-Purpose Hand Truck : Pail Truck

SPECIALTY HAND TRUCKS

Dual-Purpose Hand Truck

2-IN-1 CONVERTIBLE HAND TRUCK

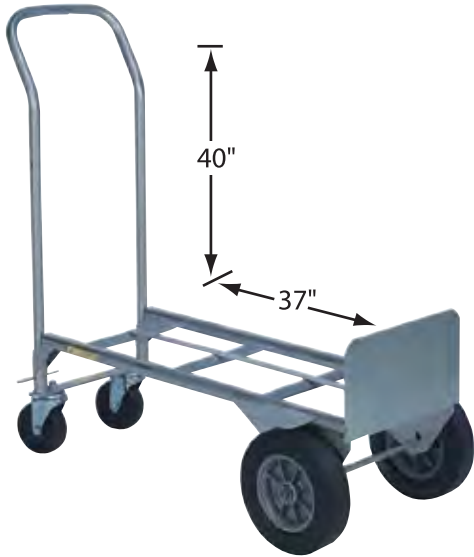

UP TO
600
LBS.



COLOR
Silver



PRODUCT HIGHLIGHTS

- **VERSATILE** – Dual-function hand truck converts to platform position for oversized loads
- **HEAVY-DUTY** – Welded, 1⁵/₁₆" OD tube frame and 1" OD tube handle powder-coated for durability
- **CAPACITY** – Holds up to 600 lbs. in platform mode

Dual-Purpose Hand Truck				
Model No.	Wheel Type	Wheel/Caster Size (In.)	Overall Height (In.)	Overall Width (In.)
RDT4008SP	Semi-Pneumatic	8 / 3	46	19-5/8
RDT4010FP	Full Pneumatic	10 / 5	46	22
RDT4010SP	Semi-Pneumatic	10 / 5	46	20



UP TO
300
LBS.

Pail Truck

TRANSPORT 5-GALLON PAILS



PRODUCT HIGHLIGHTS

- **FUNCTIONAL** – Multi-purpose hand truck for carting 5-gallon pails
- **CAPACITY** – Holds 4 pails, up to 300 lbs. weight capacity

COLOR
Gray



Pail Truck				
Model No.	Wheel Type	Wheel Size (In.)	Overall Height (In.)	Overall Width (In.)
RPT4010SP	Semi-Pneumatic	10	55-1/2	18-1/2





Akro-Tilt Trucks : Akro-Carts

BULK HANDLING & WASTE TRANSPORT SYSTEMS

Akro-Tilt Trucks



FEATURES

- 1 Wheel base and heavy-duty caster combination provide easy maneuverability even with heavy loads
- 2 Fully welded, reinforced frame is optimized for automatic dumper applications
- 3 **NEW FEATURE!** Forklift channels allow loaded Akro-Tilt Trucks to be moved and maneuvered by lift trucks, saving time, money and effort
- 4 Powder-coated tubular frame, constructed of 1.05" O.D. x 13-gauge and 1.3125" O.D. x 13-gauge wall tubes, extends under top rim for added strength
- 5 77610, 77710, 77810 feature solid 1" axle for maximum durability
- 6 Optional tow bar[‡] links carts together (order along with Tilt Truck)



UP TO
2000
LBS.



77710F



Akro-Tilt Trucks			Dimensions (In.)			Accessories		Wheels		Capacity			
Model No.	Model No. with Fork Channels	Description	W	D	H	Lid Model No.	Towbar Model No. ‡	Wheel Diameter	Wheel Type*	Gallons	Cu. Yds.	Cu. Ft.	Load Rating
77405GRAY	77405FGRAY	Medium-Duty 100	27	54	36	—	I8048	12	SP	100	1/2	13.5	600 lbs.
77410GRAY	77410FGRAY	Medium-Duty 200	33	66	42	77002	I8048	12	SP	200	1	27	600 lbs.
77505GRAY	77505FGRAY	Heavy-Duty 100	27	54	36	—	I8048	10	MR	100	1/2	13.5	1000 lbs.
77510GRAY	77510FGRAY	Heavy-Duty 200	33	66	42	77002	I8048	10	MR	200	1	27	1000 lbs.
77610GRAY	77610FGRAY	Super-Heavy-Duty 200	33	66	42	77002	I8048	12	MR	200	1	27	2000 lbs.
77710GRAY	77710FGRAY	Heavy-Duty 300	39	85	51	—	I8049	12	MR	300	1-1/2	40.5	2000 lbs.
77810GRAY	77810FGRAY	Heavy-Duty 400	48	85	51	—	I8050	12	MR	400	2	54	2000 lbs.

*SP = Semi-Pneumatic MR = Mold-On Rubber ‡Towbars can only be ordered with a unit; they are a welded frame component, place order for both at the same time.

Lid Model 77002
A full-width, heavy-duty piano hinge in the middle of the lid allows it to flip open during use.

COLOR
Gray/Gray



Akro-Carts



FEATURES

- 1 Thick, rugged tub walls
- 2 Latch bars extend around the frame for easy loading
- 3 Medium-duty and heavy-duty styles
- 4 Wide mouth and low profile for easy loading
- 5 Swivel caster for easy maneuverability and handling
- 6 Heavy-duty piano hinge allows lid to be propped open during use

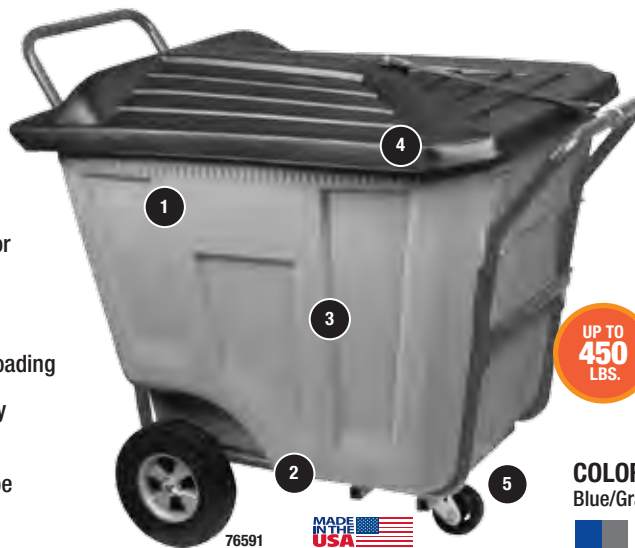

UP TO
450
LBS.



76591



COLORS
Blue/Gray, Green/Gray Gray/Gray



Akro-Carts			Dimensions (In.)								Load Rating
Model No. without Lid*	Model No. with Lid	Description	W	D	H	Wheel Size	Wheel Type	Caster	Frame		Load Rating
76460	76461	Medium-Duty 60 Gal. Cap.	30-1/2	48	33-1/2	12" x 2"	Solid Rubber	3 x 1-1/4 Thermoplastic	1" O.D. x 16 ga. galvanized w/ 5/8" solid axle		300 lbs.
76490	76491	Medium-Duty 90 Gal. Cap.	30-1/2	47	39-1/2	12" x 2"	Solid Rubber	3 x 1-1/4 Thermoplastic	1" O.D. x 16 ga. galvanized w/ 5/8" solid axle		350 lbs.
76590	76591	Heavy-Duty 90 Gal. Cap.	30-1/2	47	39-1/2	10" x 2-3/4"	Semi-Pneumatic	4 x 2 Mold-on Rubber	1.05" O.D. x 13 ga. powder-coated w/ 5/8" solid axle		450 lbs.

Please specify colors when ordering. For additional colors, call us. *Carts without lids cannot have lids added after production. Single units are shipped completely assembled. When multiple units are ordered, lids are shipped separately and require assembly.

Caster Information

HIGH-QUALITY WHEEL & CASTER OPTIONS



CASTER SELECTION GUIDE

Standard Casters & Wheels	Description	Image	Asphalt / Brick / Ceramic Tile		Carpet / Linoleum	Concrete	Steel Grate / Dock Plate	Chemicals	Debris / Metal Shavings	Slippery / Wet / Steam	Non-Marking / Floor Protection	Noise	Cushion Load	Impact Resistance	Caster Weight Capacity	Rolling Ease	Standing Loads / Long Term Storage	
			Floor Surface			Floor Conditions			Other Factors to Consider									
Mold-On Rubber, Blue Elastic	Designed for medium to heavy loads, these wheels with cushioned rubber tread are quiet and provide good floor protection.		■	⊗	■	▣	⊗	⊗	▣	▣	■	■	■	▣	▣	▣	▣	⊗
Phenolic	For demanding applications, a less expensive wheel that offers high strength, is non-marking, non-conductive and protects floors.		⊗	▣	■	⊗	▣	⊗	⊗	▣	▣	■	⊗	▣	■	■	■	
Polyolefin	A heavy-duty, lightweight, non-marking plastic wheel that resists most chemicals and oils, and has excellent impact resistance.		⊗	▣	■	⊗	■	▣	■	▣	▣	▣	⊗	■	▣	■	⊗	
Polyurethane	Chemically bonded to a metal core, polyurethane wheels are more durable than other materials, deliver excellent mobility, a cushioned ride and long life when subjected to heavy loads.		■	▣	■	▣	▣	▣	▣	▣	■	■	▣	■	■	▣	⊗	
Pneumatic, Semi-Pneumatic	Air-filled for excellent shock protection, floor protection and easy operation over rough surfaces.		■	⊗	■	■	⊗	⊗	▣	▣	▣	■	■	■	▣	⊗	⊗	
Steel	A good choice for warehouses and manufacturing operations, and where noise or floor protection are not a concern. Metal wheels offer the least rolling resistance.		⊗	⊗	■	⊗	▣	■	▣	▣	⊗	⊗	⊗	■	■	■	■	
Thermoplastic, Gray Non-Marking Rubber	Soft gray rubber wheel provides excellent floor protection and a cushioned ride while resisting chemicals, acids, oils and caustic substances.		■	▣	■	▣	■	▣	■	■	■	■	■	■	▣	▣	⊗	
Easy-Roll	Thermoplastic rubber with superior precision bearings. Non-marking wheel rolls effortlessly over most surfaces; ideal for indoor use such as offices or hospitals.		■	■	■	▣	■	▣	▣	■	■	■	■	■	▣	▣	⊗	

■ = Excellent ▣ = Ok ⊗ = Not Recommended

CASTERS & WHEELS

Our generous selection of caster and wheel options allows platform trucks, hand trucks, dollies and shelf carts to be customized to fit hundreds of applications, surfaces and conditions. Caster and wheel choices allow you to resolve problems of noise control, floor protection, impact and abrasion resistance or load capacity.

Caster	Caster Weight Capacities (Lbs.)*						
	10	8	6	5	4	3.5	3
Mold-On Rubber, Blue Elastic	3200	2200	1600	1400	1200	-	-
Phenolic	14,000	4200	3600	3600	-	-	-
Pneumatic	1500	1200	-	-	-	-	-
Polyolefin	-	3200	2600	1800	1000	-	900
Polyurethane	8800	4200	3600	3600	-	-	-
Semi-Pneumatic	2200	-	-	-	-	-	-
Steel	-	4200	3600	3600	1200	-	1000
Thermoplastic	-	600 [†]	-	400 [†]	-	-	-
Gray Non-Marking Rubber	-	-	2000	-	-	1000	-
Easy-Roll	-	-	2000	-	-	-	-

*Based on evenly distributed load on 4 casters. †Light-duty.

Akro-Mils offers other premium casters for your custom products. Call 800-253-2467 for details.

IT'S ALL ABOUT THE WHEEL



Those that depend upon platform trucks, carts and dollies to do their jobs understand that the right caster makes ALL the difference.

For example, not all 3" polyolefin casters are built the same, even if they look similar. Akro-Mils gives you more:

- ➔ **Double Ball Race vs. Single Ball Race.**
This provides better rotation and control.
- ➔ **Sealed Wheel Hub Ball Bearings vs. Plain Bore.**
This provides better overall roll ability.
- ➔ **More Structural Wheel Profile.**
Allows the wheel to be stronger under impact.
- ➔ **Heat-Treated Plate Raceway vs. Non Heat-Treated.**
This provides better support under load conditions.

GET MORE OF WHAT YOU PAID FOR WITH AKRO-MILS!

Product Index

MATERIAL HANDLING : STORAGE : TRANSPORT PRODUCTS

02420.....	43	30124.....	16	30536235S.....	37	30906.....	81	37672.....	29	40901.....	46
05705.....	42	30128.....	16	30536320S.....	37	30930.....	81	37676.....	29	40909.....	46
05805.....	42	30130.....	16	30553.....	37	30936.....	81	37678.....	29	41103.....	27
05905.....	42	30138.....	16	30553210S.....	37	31112.....	21, 83	37682.....	29	41105.....	27
06115.....	42	30148.....	38	30553220S.....	37	31118.....	21, 83	37686.....	29	41162.....	27
06118.....	42	30150.....	16	30553230S.....	37	31142.....	21, 83	37688.....	29	41164.....	27
06702.....	45	30158.....	16	30553235S.....	37	31148.....	21, 83	38004RED.....	28	41165.....	27
06702CUP.....	45	30161.....	33	30553A1.....	37	31162.....	21, 83	38008YEL.....	28	41166.....	27
06703.....	45, 82	30164.....	16	30553A3.....	37	31164.....	21, 83	38358GRY.....	28	41168.....	27
06703CUP.....	45	30170.....	16	30553A5.....	37	31168.....	21, 83	39085.....	23	41220.....	27
06704.....	45, 82	30174.....	16	30553B1.....	37	31182.....	21, 83	39120.....	23	41222.....	27
06704CUP.....	45	30178.....	16	30553LF.....	37	31188.....	21, 83	39160.....	23	41223.....	27
06705.....	45, 82	30184.....	16	30600BRACKET.....	31	31620.....	31	39170.....	23	41224.....	27
06705CUP.....	45	30210.....	5	30600DOLLY.....	31	31625.....	31	39175.....	23	41226.....	27
06706.....	45	30210ESD.....	9	30606DOLLY.....	34	31625SRACK.....	31	39280.....	23	41228.....	27
06706CUP.....	45	30211CRY.....	5	30606GY.....	34	33011.....	27	40000.....	14	41230.....	5
06709.....	45	30220.....	5	30606GY240.....	34	33023.....	27	40020.....	17	41250.....	5
06709CUP.....	45	30220ESD.....	9	30606GY250.....	34	33061.....	27	40030.....	17	41270.....	5
09185BLUE.....	43	30221CRY.....	5	30606GYASST.....	34	33103.....	27	40040.....	17	41284.....	11
09185SCLAR.....	43	30224.....	5	30607GY.....	34	33105.....	27	40050.....	17	41286.....	11
09514.....	43	30225CRY.....	5	30607GY240.....	34	33162.....	27	40120.....	16, 20	41287.....	11
09912.....	43	30230.....	5	30607GY250.....	34	33164.....	27	40130.....	16, 20	41288.....	11
10116.....	48	30230ESD.....	9	30607GYASST.....	34	33165.....	27	40150.....	16	41289.....	11
10124.....	48	30231CRY.....	5	30618.....	33	33166.....	27	40170.....	16	41410.....	21
10126.....	48	30234.....	5	30618BEIGE.....	33	33168.....	27	40210.....	5	41440.....	21
10144.....	48	30235.....	5	30635AGY.....	33	33220.....	27	40210CRY.....	5	41460.....	21
10164.....	48	30235ESD.....	9	30635GY.....	33	33222.....	27	40220.....	5	41480.....	21
13014.....	12	30236CRY.....	5	30636.....	33	33223.....	27	40220CRY.....	5	415A1.....	8
13017.....	12	30237.....	5	30636BEIGE1.....	33	33224.....	27	40224.....	5	415B1.....	8
13018.....	12	30239.....	5	30636BEIGE3.....	33	33226.....	27	40224CRY.....	5	41814.....	19
17018.....	46	30240.....	5	30636BEIGE5.....	33	33228.....	27	40228.....	46	41818.....	19
19109.....	46	30240ESD.....	9	30636BEIGE1.....	33	34005.....	30	40230.....	5	41820.....	19
19228.....	46	30250.....	5	30637.....	36	34240.....	30	40230CRY.....	5	41826.....	19
19320.....	46	30255.....	5	30637A.....	36	34301.....	30	40234.....	5	42103.....	27
19416.....	46	30260.....	5	30638.....	33	34302.....	30	40234CRY.....	5	42105.....	27
19715.....	46	30265.....	5	30650GY.....	34	34303.....	30	40237.....	5	42162.....	27
19909.....	46	30270.....	5	30650GY240.....	34	34304.....	30	40237CRY.....	5	42164.....	27
20228.....	46	30280.....	11	30650GY250.....	34	34305.....	30	40239.....	5	42165.....	27
20320.....	46	30280L.....	11	30650GYASST.....	34	35010.....	25, 27	40239CRY.....	5	42166.....	27
20416.....	46	30281.....	11	30651.....	33	35011.....	25, 27	40245.....	5	42168.....	27
20701.....	48	30281L.....	11	30652.....	36	35180.....	25	40245CRY.....	5	42220.....	27
20702.....	48	30282.....	11	30653.....	33	35181.....	25	40260.....	5	42222.....	27
20715.....	46	30282L.....	11	30653DOLLY.....	33, 36	35185.....	25	40260CRY.....	5	42223.....	27
20902.....	46	30283.....	11	30654.....	36	35190.....	25	40265.....	5	42224.....	27
20909.....	46	30283L.....	11	30655.....	33	35191.....	25	40265CRY.....	5	42226.....	27
21280.....	11	30284.....	11	30656GY.....	34	35195.....	25	40270.....	5	42228.....	27
21281.....	11	30286.....	11	30656GY240.....	34	35200.....	25	40270CRY.....	5	45612.....	58
21282.....	11	30286L.....	11	30656GY250.....	34	35201.....	25	40280.....	11	45618.....	58
21283.....	11	30287.....	11	30656GYASST.....	34	35225.....	25	40281.....	11	45624.....	58
21284.....	11	30288.....	11	30658.....	33	35230.....	25	40282.....	11	46110.....	7
21286.....	11	30288MOB.....	11	30661.....	33	35231.....	25	40286.....	11	46220.....	7
21287.....	11	30289.....	11	30676.....	33	35240.....	25	40287.....	11	48300.....	28
21288.....	11	30289MOB.....	11	30716BLACK.....	22	35241.....	25	40289.....	11	48301.....	28
21289.....	11	30290.....	11	30718BLACK.....	22	35300.....	25	40290.....	11	66486CLDBL.....	23
29200.....	13, 16	30290L.....	11	30776BLACK.....	22	35301.....	25	40292.....	11	76460.....	90
29201.....	13, 16	30290MOB.....	11	30778BLACK.....	22	36110.....	7	40312.....	22	76461.....	90
29202.....	5, 13	30292.....	11	30796BLACK.....	22	36111CRY.....	7	40320.....	46	76490.....	90
29203.....	5, 13, 27	30292MOB.....	11	30800.....	19	36120.....	7	40321.....	5	76491.....	90
29300.....	13, 16	30293.....	11	30804.....	19	36121CRY.....	7	40348.....	9	76590.....	90
29301.....	5, 13, 17	30293MOB.....	11	30806.....	19	36130.....	7	40358.....	9	76591.....	90
29302.....	5, 13	30312.....	22	30808.....	19	36131CRY.....	7	40410.....	15	77002.....	90
29303.....	5, 13	30318.....	22	30812.....	38	36140.....	7	40411.....	15	77405FGGRAY.....	90
29304.....	11, 13	30320.....	5	30814.....	19	36141CRY.....	7	40412.....	15	77405GRAY.....	90
29306.....	14, 57	30321.....	5	30818.....	19	36220.....	7	40416.....	46	77410FGGRAY.....	90
30008.....	38	30348BEIGE.....	9	30820.....	19	36221CRY.....	7	40442.....	20	77410GRAY.....	90
30010.....	17	30358BEIGE.....	9	30824.....	19	36230.....	7	40462.....	20	77505FGGRAY.....	90
30014.....	17	30424.....	38, 47	30826.....	19	36231CRY.....	7	40599.....	5	77505GRAY.....	90
30016.....	38, 47	305A1.....	8	30828.....	19	36240.....	7	405A1.....	8	77510FGGRAY.....	90
30018.....	17	305A2.....	8	30838.....	19	36241CRY.....	7	405A3.....	8	77510GRAY.....	90
30040.....	17	305A3.....	8	30840.....	19	36442BLKRED.....	20	405A5.....	8	77610FGGRAY.....	90
30044.....	17	305A4.....	8	30844.....	19	36442BLUE.....	20	405B1.....	8	77610GRAY.....	90
30048.....	17	305A5.....	8	30846.....	19	36448BLKRED.....	20	40703.....	45, 82	77710FGGRAY.....	90
30080.....	17	305A6.....	8	30848.....	19	36448BLUE.....	20	40704.....	45, 82	77710GRAY.....	90
30084.....	17	305B1.....	8	30860.....	19	36462BLKRED.....	20	40715.....	46	77810FGGRAY.....	90
30088.....	17	305B2.....	8	30864.....	19	36462BLUE.....	20	40716.....	48	77810GRAY.....	90
30090.....	17	30536.....	37	30866.....	19	36468BLKRED.....	20	40717.....	48	98318GY.....	35
30094.....	17	30536A1.....	37	30868.....	19	36468BLUE.....	20	40800.....	19	98318GY2055.....	35
30098.....	17	30536A3.....	37	30880.....	19	37208.....	29	40818.....	19	98318GY2430.....	35
30101.....	16	30536A5.....	37	30884.....	19	37278.....	29	40820.....	19	98325.....	47
30102.....	16	30536B1.....	37	30886.....	19	37288.....	29	40838.....	19	96352A.....	42
30110.....	16	30536210S.....	37	30888.....	19	37608.....	29	40840.....	19	96352B.....	42
30118.....	33	30536220S.....	37	30900.....	81	37612.....	29	40860.....	19	98400.....	38, 46, 47
30120.....	16	30536230S.....	37	30902.....	81	37616.....	29	40880.....	19	98536.....	37

Product Index

MATERIAL HANDLING : STORAGE : TRANSPORT PRODUCTS

98600.....	35	AD3511CAST2.....	54	APRS18118.....	41	ASC1879148.....	65	AWS3672SHELF.....	56
98636.....	35	AD3511P.....	54	APRS18128.....	41	ASC1879168.....	65	AWS24360SAB.....	61
98536210SD.....	37	AD3511P62.....	54	APRS18138.....	41	ASC1879188.....	65	AWS541224SU.....	59
98536210SS.....	37	AD3511P82.....	54	APRS18148.....	41	AW18DPBKT.....	58	AWS541236SU.....	59
98536220SD.....	37	AD3511PAST2.....	54	APRS18158.....	41	AW18DWBKT.....	58	AWS541248SU.....	59
98536220SS.....	37	AD3517BSC.....	54	APRS18168.....	41	AW18SPBKT.....	58	AWS541436SU.....	59
98536230SD.....	37	AD3517BSP.....	54	APRS18178.....	41	AW18SWBKT.....	58	AWS541824SU.....	59
98536230SS.....	37	AD3517C.....	54	APRS18188.....	41	AW24DPBKT.....	58	AWS541830SU.....	59
98536235SD.....	37	AD3517C68.....	54	APRS18318.....	41	AW24DWBKT.....	58	AWS541836SU.....	59
98536235SS.....	37	AD3517C88.....	54	APRS36442B.....	40	AW24SPBKT.....	58	AWS541848SU.....	59
98536320SD.....	37	AD3517CAST.....	54	APRS36462B.....	40	AW24SWBKT.....	58	AWS541860SU.....	59
98536320SS.....	37	AD3517CAST2.....	54	APRS1836448.....	41	AW1224LINER.....	57	AWS541872SU.....	59
		AD3517P.....	54	APRS1836468.....	41	AW1236LINER.....	57	AWS542424SU.....	59
		AD3517P68.....	54	APRSAST.....	40	AW1248LINER.....	57	AWS542436SU.....	59
A		AD3517P88.....	54	APRSAST00.....	40	AW1824LINER.....	57	AWS542448SU.....	59
AC3618.....	50	AD3517PAST.....	54	AS1279.....	64	AW1836FRAME.....	57	AWS542460SU.....	59
AC3618KD1ASY.....	49	AD3517PAST2.....	54	AS1879.....	64	AW1836LINER.....	57	AWS542472SU.....	59
AC3618KD4AS.....	49	APRBENCH.....	39	AS1879ASORT.....	66	AW1848FRAME.....	57	AWS543648SU.....	59
AC3618QV.....	51, 52	APRBENCH010.....	39	AS2479.....	64	AW1848LINER.....	57	AWS543660SU.....	59
AC3618QV240.....	51	APRBENCH040.....	39	AS2479ASSORT.....	65	AW1860LINER.....	57	AWS543672SU.....	59
AC3618QV250.....	51	APRBENCH090.....	39	AS3679.....	64	AW1872LINER.....	57	AWS631224SU.....	59
AC3618QVTV1.....	52	APRBENCH120.....	39	AS3679ASSORT.....	65	AW2424LINER.....	57	AWS631236SU.....	59
AC3618QVTV2.....	52	APRBENCH150.....	39	AS187936.....	64	AW2436FRAME.....	57	AWS631248SU.....	59
AC3618RT.....	49	APRBENCH312.....	39	AS187942.....	64	AW2436LINER.....	57	AWS631436SU.....	59
AC3618SV.....	51	APRD.....	39	AS1279010.....	66	AW2448FRAME.....	57	AWS631824SU.....	59
AC3618SV240.....	51	APRD010.....	40	AS1279040.....	66	AW2448LINER.....	57	AWS631830SU.....	59
AC3618SV250.....	51	APRD18.....	39	AS1279080.....	66	AW2460LINER.....	57	AWS631836SU.....	59
AC3618Y.....	50	APRD18AST00.....	41	AS1279090.....	66	AW2472LINER.....	57	AWS631848SU.....	59
AC3618SHELF1PK.....	49, 50	APRD18MOBILE.....	39	AS1279110.....	66	AW3660LINER.....	57	AWS631860SU.....	59
AC3618SHELF4PK.....	50	APRD040.....	40	AS1279120.....	66	AW3672LINER.....	57	AWS631872SU.....	59
AC3624.....	50	APRD080.....	40	AS1279130.....	66	AWCLAMP2PK.....	57	AWS632424SU.....	59
AC3624Y.....	50	APRD090.....	40	AS1279150.....	66	AWCLIP4PK.....	57	AWS632436SU.....	59
AC3624Y3AS.....	50	APRD110.....	40	AS1279170.....	66	AWDVIDER12.....	58	AWS632448SU.....	59
AC36243AS.....	50	APRD112.....	40	AS1279312.....	66	AWDVIDER18.....	58	AWS632460SU.....	59
AC803618M26.....	49, 50	APRD120.....	40	AS1879018.....	67	AWDVIDER24.....	58	AWS632472SU.....	59
AC803624M26.....	50	APRD130.....	40	AS1879048.....	66	AWDVIDER36.....	58	AWS633648SU.....	59
ACKEY.....	49, 50, 53	APRD142.....	40	AS1879088.....	66	AWDONUT.....	57	AWS633660SU.....	59
ACKEYF.....	50	APRD150.....	40	AS1879098.....	66	AWFOOTLEVEL4PK.....	57	AWS633672SU.....	59
ACQV4C.....	53	APRD162.....	40	AS1879128.....	66	AWFOOTPLATE4PK.....	57	AWS741224SU.....	60
ACQV4C42.....	53	APRD170.....	40	AS1879138.....	66	AWLEDGE12.....	58	AWS741236SU.....	60
ACQV4C62.....	53	APRD182.....	40	AS1879158.....	66	AWLEDGE18.....	58	AWS741248SU.....	60
ACQV4C82.....	53	APRD312.....	40	AS1879178.....	66	AWLEDGE24.....	58	AWS741436SU.....	60
ACQV4CAST.....	53	APRD18018.....	41	AS1879318.....	67	AWLEDGE36.....	58	AWS741824SU.....	60
ACQV4P.....	53	APRD18048.....	41	AS2479014.....	66	AWLEDGE48.....	58	AWS741830SU.....	60
ACQV4P42.....	53	APRD18088.....	41	AS2479044.....	66	AWLEDGE60.....	58	AWS741836SU.....	60
ACQV4P62.....	53	APRD18098.....	41	AS2479084.....	66	AWLEDGE72.....	58	AWS741848SU.....	60
ACQV4P82.....	53	APRD18118.....	41	AS2479094.....	66	AWP34UPRIGHT.....	56	AWS741860SU.....	60
ACQV4PAST.....	53	APRD18128.....	41	AS2479284.....	65	AWP54UPRIGHT.....	56	AWS741872SU.....	60
ACS4C.....	53	APRD18138.....	41	AS2479287.....	65	AWP63UPRIGHT.....	56	AWS742424SU.....	60
ACS4C42.....	53	APRD18148.....	41	AS2479288.....	65	AWP74UPRIGHT.....	56	AWS742436SU.....	60
ACS4C62.....	53	APRD18158.....	41	AS3679292.....	65	AWP86UPRIGHT.....	56	AWS742448SU.....	60
ACS4C82.....	53	APRD18168.....	41	AS3679293.....	65	AWP96UPRIGHT.....	56	AWS742460SU.....	60
ACS4CAST.....	53	APRD18178.....	41	AS127930800.....	67	AWPCAST4.....	57	AWS742472SU.....	60
ACS4P.....	53	APRD18188.....	41	AS127930804.....	67	AWPCAST5.....	57	AWS743648SU.....	60
ACS4P42.....	53	APRD18318.....	41	AS127930860.....	67	AWPHDL18.....	58	AWS743660SU.....	60
ACS4P62.....	53	APRD36442B.....	40	AS127930880.....	67	AWPHDL24.....	58	AWS743672SU.....	60
ACS4P82.....	53	APRD36462B.....	40	AS127936442B.....	67	AWS1224SHELF.....	56	AWS861224SU.....	60
ACS4PAST.....	53	APRD1836448.....	41	AS127936462B.....	67	AWS1236SHELF.....	56	AWS861236SU.....	60
AD1811C.....	55	APRD1836468.....	41	AS187913014.....	66	AWS1248SHELF.....	56	AWS861248SU.....	60
AD1811C62.....	55	APRDAST.....	40	AS187913017.....	66	AWS1436SHELF.....	56	AWS861436SU.....	60
AD1811C82.....	55	APRDAST00.....	40	AS187913018.....	66	AWS1824SHELF.....	56	AWS861824SU.....	60
AD1811CAST.....	55	APRDMOBILE.....	39	AS187930808.....	67	AWS1830SHELF.....	56	AWS861830SU.....	60
AD1811P.....	55	APRS.....	39	AS187930818.....	67	AWS1836M34301.....	63	AWS861836SU.....	60
AD1811P62.....	55	APRS010.....	40	AS187930838.....	67	AWS1836SHELF.....	56	AWS861848SU.....	60
AD1811P82.....	55	APRS18.....	39	AS187930848.....	67	AWS1836SL.....	57	AWS861860SU.....	60
AD1811PAST.....	55	APRS18AST00.....	41	AS187930868.....	67	AWS1836SNS.....	61	AWS861872SU.....	60
AD1817C.....	55	APRS040.....	40	AS187930888.....	67	AWS1848SAB.....	61	AWS862424SU.....	60
AD1817C68.....	55	APRS080.....	40	AS187936448B.....	67	AWS1848SHELF.....	56	AWS862436SU.....	60
AD1817C88.....	55	APRS090.....	40	AS187936468B.....	67	AWS1848SL.....	57	AWS862448SU.....	60
AD1817CAST.....	55	APRS110.....	40	AS247930804.....	67	AWS1860SHELF.....	56	AWS862460SU.....	60
AD1817P.....	55	APRS112.....	40	AS247930814.....	67	AWS1872SHELF.....	56	AWS862472SU.....	60
AD1817P68.....	55	APRS120.....	40	AS247930844.....	67	AWS2424SHELF.....	56	AWS863648SU.....	60
AD1817P88.....	55	APRS130.....	40	AS247930864.....	67	AWS2436SHELF.....	56	AWS863660SU.....	60
AD1817PAST.....	55	APRS142.....	40	AS247930884.....	67	AWS2436SL.....	57	AWS863672SU.....	60
AD2311C.....	55	APRS150.....	40	ASC1279.....	64	AWS2448SHELF.....	56	AWS24360284.....	61
AD2311C62.....	55	APRS162.....	40	ASC1279AST.....	65	AWS2448SL.....	57	AWS24360287.....	61
AD2311P.....	55	APRS170.....	40	ASC1879.....	64	AWS2460M30358.....	61	AWS24360288.....	61
AD2311P62.....	55	APRS182.....	40	ASC1879AST.....	65	AWS2460M33224.....	63	AWS24361288.....	61
AD3511BSC.....	54	APRS312.....	40	ASC1279112.....	65	AWS2460M34240.....	63	AWS143630010.....	62
AD3511BSP.....	54	APRS18018.....	41	ASC1279142.....	65	AWS2460SHELF.....	56	AWS143630040.....	62
AD3511C.....	54	APRS18048.....	41	ASC1279162.....	65	AWS2472SHELF.....	56	AWS143630080.....	62
AD3511C62.....	54	APRS18088.....	41	ASC1279182.....	65	AWS3648SHELF.....	56	AWS143630090.....	62
AD3511C82.....	54	APRS18098.....	41	ASC1879118.....	65	AWS3660SHELF.....	56	AWS143630120.....	61

Product Index

MATERIAL HANDLING : STORAGE : TRANSPORT PRODUCTS

AWS143630130.....	61	LPP3WL.....	33	R90162A1412.....	75	RD853SS.....	68	RU843HR1624.....	29, 69	U90181D3817.....	77
AWS143630150.....	61	LPP6NL.....	33	R90162D3815.....	75	RD854HR.....	68	RU843HR1822.....	25, 69	U90181G14112817.....	77
AWS143630170.....	61	LPP6SP.....	33	R90162P24111811.....	75	RD854SS.....	68	RU843HR1828.....	25, 69	U90181H24121817.....	77
AWS143630240.....	61	LPP6WL.....	33	R90163A1411.....	75	RD2416F3P.....	70	RU843HR2018.....	69	U90181L24112817.....	77
AWS143630250.....	61	LVDMOBILE.....	33	R90163A1412.....	75	RD2416R3P.....	70	RU843HR2918.....	69	U90182A1411.....	77
AWS143630312.....	63			R90163D3815.....	75	RD2416S3P.....	70	RU843SS.....	68	U90182A1412.....	77
AWS143630320.....	61			R90163F44813.....	75	RD2718F3P.....	70	RU843TP1721.....	69	U90182B2412.....	77
AWS143630800.....	62	M		R90163P24111811.....	75	RD2718RC3P.....	70	RU843TP1727.....	69	U90182D3817.....	77
AWS143630840.....	62	MA3618C.....	83	R90165A1411.....	75	RD2718S3P.....	70	RU843TP1821.....	69	U90182G14112817.....	77
AWS143630860.....	62	MA3618C1.....	83	R90165A1412.....	75	RD3018AC3P.....	70	RU843TP2122.....	69	U90182H24121817.....	77
AWS143630880.....	62	MA3618CAST.....	83	R90165B2412.....	75	RD3018CE3P.....	70	RU843TP2227.....	69	U90182L24112817.....	77
AWS143630880.....	62	MA3618P.....	83	R90165S2411.....	75	RD3018F3P.....	70	RU844HR.....	68	U90184A1411.....	77
AWS143630880.....	62	MA3618P1.....	83	R90181A1411.....	75	RD3018R3P.....	70	RU844SS.....	68	U90184A1412.....	77
AWS143636462B.....	62	MA4824C.....	83	R90181A1412.....	75	RD3018RC3P.....	70	RU853HR.....	68	U90184B2412.....	77
AWS183613014.....	61	MA4824C1.....	83	R90181B2412.....	75	RD3018S3P.....	70	RU853SS.....	68	U90184G14112817.....	77
AWS183613018.....	61	MA4824C2.....	83	R90181D3815.....	75	RD3624AC3P.....	70	RU854HR.....	68	U90184L24112817.....	77
AWS183630018.....	62	MA4824C3.....	83	R90181F44813.....	75	RD3624CE3P.....	70	RU854SS.....	68	U90185A1411.....	77
AWS183630048.....	62	MA4824C4.....	83	R90181P24111811.....	75	RD3624F3P.....	70	RWH2448EA5M6.....	79	U90185A1412.....	77
AWS183630088.....	62	MA4824P1.....	83	R90181S2411.....	75	RD3624R3P.....	70	RWH2448EA5M6A.....	79	U90210A1011.....	77
AWS183630098.....	62	MA4824P2.....	83	R90182A1411.....	75	RD3624S3P.....	70	RWH3060EA5M6.....	79	U90210A1012.....	77
AWS183630128.....	61	MA4824P3.....	83	R90182A1412.....	75	RD4824F3P.....	70	RWH3060EA5M6A.....	79	U90210B2012.....	77
AWS183630138.....	61			R90182B2412.....	75	RD4824S3P.....	70	RWH24481A5M8.....	78	U90210G10112017.....	77
AWS183630158.....	61	R		R90182D3815.....	75	RDT4008SP.....	89	RWH24481A5M8A.....	78	U90210L20112017.....	77
AWS183630178.....	61	R1B5HR.....	85	R90182F44813.....	75	RDT4010FP.....	89	RWH30601A5M8.....	78	U90262A1011.....	77
AWS183630265.....	61	R1B5HRL.....	85	R90182P24111811.....	75	RDT4010SP.....	89	RWH30601A5M8A.....	78	U90262A1012.....	77
AWS183630270.....	63	R1B5HRX.....	85	R90182S2411.....	75	RF718MR.....	79	RWH30601A5M6.....	79	U90262D3017.....	77
AWS183630318.....	61	R1B5HRXL.....	85	R90184A1411.....	75	RGTD10FP.....	88	RWHS2448EA5M6A.....	79	U90262H20121017.....	77
AWS183630808.....	62	R1S5HR.....	84	R90184A1412.....	75	RGTD10SP.....	88	RWHS3060EA5M6.....	79	U90263A1011.....	77
AWS183630818.....	62	R1S5HRLD.....	84	R90184B2412.....	75	RGTS10FP.....	88	RWHS3060EA5M6A.....	79	U90263A1012.....	77
AWS183630838.....	62	R1S5HR2L.....	84	R90184F44813.....	75	RGTS10SP.....	88	RWHS24481A5M8.....	78	U90263D3017.....	77
AWS183630848.....	62	R1S8FP2.....	84	R90184S2411.....	75	RHDLH00K.....	68	RWHS24481A5M8A.....	78	U90263H20121017.....	77
AWS183630868.....	62	R1S8MR.....	84	R90185A1411.....	75	RHWB2448P5P0G.....	86	RWHS24481A5Y6.....	78	U90263L20112017.....	77
AWS183630888.....	62	R1S8MR2.....	84	R90185A1412.....	75	RHWB3060.....	87	RWHS24481A5Y6A.....	78	U90265A1011.....	77
AWS183633166.....	63	R1S10FP2.....	84	R90210A1011.....	75	RHWB3072.....	87	RWHS30601A5M8.....	78	U90265A1012.....	77
AWS183633168.....	63	R2S5HR.....	84	R90210A1012.....	75	RM718MR.....	79	RWHS30601A5M8A.....	78	U90281A1011.....	77
AWS183635180.....	63	R2T5HR1830.....	85	R90210B2012.....	75	RMD2S5SSR.....	86	RWHS30601A5Y6.....	78	U90281A1012.....	77
AWS183636448B.....	62	R2T5HR2436.....	85	R90210F40013.....	75	RMD3T5SSR.....	86	RWHS30601A5Y6A.....	78	U90281B2012.....	77
AWS183636468B.....	62	R2T5HR2448.....	85	R90210S2011.....	75	RMD3018F4PN.....	71	RWHV2448EA5M6.....	79	U90281D3017.....	77
AWS184813017.....	61	R2T8MR2448.....	85	R90262A1011.....	75	RMD3018F4RX.....	71	RWHV3060EA5M6A.....	79	U90281G10112017.....	77
AWS184830260.....	61	R3S5HR.....	84	R90262A1012.....	75	RMD3018FN.....	71	RWHV3060EA5M6.....	79	U90281H20121017.....	77
AWS184830280.....	61	R4S5HR.....	84	R90262D3015.....	75	RMD3018RC4PN.....	71	RWHV3060EA5M6A.....	79	U90281L20112017.....	77
AWS184830281.....	61	R4S5HR.....	84	R90262P20111011.....	75	RMD3018RC4RX.....	71	RWHV24481A5M8.....	78	U90282A1011.....	77
AWS184830282.....	61	R5S5HR.....	84	R90263A1011.....	75	RMD3018RCN.....	71	RWHV24481A5M8A.....	78	U90282A1012.....	77
AWS184830283.....	61	R5S5HR.....	84	R90263A1012.....	75	RMBW2448S5SRTPG.....	86	RWHV24481A5Y6.....	78	U90282B2012.....	77
AWS243630014.....	62	R5SYT5HR2436.....	84	R90263D3015.....	75	RPT2448.....	72	RWHV24481A5Y6A.....	78	U90282D3017.....	77
AWS243630044.....	62	R5SYT5HR3636.....	84	R90263F40013.....	75	RPT2754.....	72	RWHV30601A5M8.....	78	U90282G10112017.....	77
AWS243630084.....	62	R5SYT8MR2436.....	84	R90263P20111011.....	75	RPT3060.....	72	RWHV30601A5M8A.....	78	U90282H20121017.....	77
AWS243630084.....	62	R5SYT8MR3636.....	84	R90265A1011.....	75	RPT3672.....	72	RWHV30601A5Y6.....	78	U90282L20112017.....	77
AWS243630804.....	62	R214CS1841.....	85	R90265A1012.....	75	RPT4010SP.....	89	RWHV30601A5Y6A.....	78	U90284A1011.....	77
AWS243630814.....	62	R214CS1859.....	85	R90265B2012.....	75	RPT24485J5G6GY.....	80			U90284A1012.....	77
AWS243630844.....	62	R214CS1878.....	85	R90265S2011.....	75	RPT24485J5M8GY.....	80			U90284B2012.....	77
AWS243630864.....	62	R214CS2841.....	85	R90281A1011.....	75	RPT24485J5N8GY.....	80			U90284G10112017.....	77
AWS243630884.....	62	R214CS2859.....	85	R90281A1012.....	75	RPT24485J5P6GY.....	80			U90284L20112017.....	77
AWS244830124.....	61	R214CS2878.....	85	R90281B2012.....	75	RPT24485K5G6GY.....	80			U90285A1011.....	77
AWS244830164.....	61	R216CS2236.....	85	R90281D3015.....	75	RPT24485K5M8GY.....	80			U90285A1012.....	77
AWS244830174.....	61	R216CS2239.....	85	R90281F40013.....	75	RPT24485K5N8GY.....	80				
AWS244830184.....	61	R216CS2836.....	85	R90281P20111011.....	75	RPT27545J5G6GY.....	80				
AWS244830348BE.....	61	R1130BRK.....	70	R90281S2011.....	75	RPT27545J5M8GY.....	80				
AWS244837608.....	63	R1151BRK.....	70	R90282A1011.....	75	RPT27545J5N8GY.....	80				
AWS246035225.....	63	R1495.....	70	R90282A1012.....	75	RPT27545J5P6GY.....	80				
AWSH00K8PK.....	57	R2108FPB.....	73	R90282B2012.....	75	RPT27545K5G6GY.....	80				
AUWHDL18.....	58	R2125MRB.....	73	R90282D3015.....	75	RPT27545K5M8GY.....	80				
AUWHDL24.....	58	R2168MRB.....	73	R90282F40013.....	75	RPT27545K5N8GY.....	80				
		R2178MRB.....	73	R90282P20111011.....	75	RPT27545K5P6GY.....	80				
		R219885MRB.....	73	R90282S2011.....	75	RPT30605J5G6GY.....	80				
		R221812MRB.....	73	R90284A1011.....	75	RPT30605J5M8GY.....	80				
		R2258516MRB.....	73	R90284A1012.....	75	RPT30605J5N8GY.....	80				
		R3008MR.....	88	R90284B2012.....	75	RPT30605J5P6GY.....	80				
		R3010FP.....	88	R90284F40013.....	75	RPT30605K5G6GY.....	80				
		R3010SP.....	88	R90285A2011.....	75	RPT30605K5M8GY.....	80				
		R4008MR.....	88	R90285A1011.....	75	RPT30605K5N8GY.....	80				
		R4008MR2.....	88	R90285A1012.....	75	RPT30605K5P6GY.....	80				
		R4010FP.....	88	RA6TR4MR.....	30	RSSAKBINHDDWN6.....	85				
		R4010FP2.....	88	RA756MR.....	79	RSSAKBINHDDWN9.....	85				
		R4010SP.....	88	RA778MR.....	79	RSSAKBINHDDWN12.....	85				
		R4510SP.....	88	RA78MR.....	30	RTOWHANDLE.....	70				
		R4510SP2.....	88	RCT40LW.....	88	RU843HR.....	68				
		R90110A1411.....	75	RCTV40SP.....	88	RU843HR1420.....	23, 69				
		R90110A1412.....	75	RD843HR.....	68	RU843HR1422.....	25, 69				
		R90110B2412.....	75	RD843SS.....	68	RU843HR1519.....	69				
		R90110F44813.....	75	RD844HR.....	68	RU843HR1617.....	69				
		R90110S2411.....	75	RD844SS.....	68	RU843HR1621.....	27, 69				
		R90162A1411.....	75	RD853HR.....	68						

OEM & Merchandising

CUSTOM SOLUTIONS

Engineering & Design

Akro-Mils' team of engineers and designers draws on a wealth of experience across products and industries to offer creative, practical solutions for your specific needs. With the latest design software and production equipment, your project is guided from concept to delivery in a process that incorporates quality from start to finish.

- Ability to create models for new product ideas, communications to customers and support to engineering.
- Process and Material Selection for new product ideas. Materials Manager (Ph.D) internal resource available for OEM-specific needs.
- Prototype Design, Testing and Development with complete part stress analysis through partner relationships with Myers Industries.
- Rapid Prototyping by means of plastic 3-D printing capabilities.
- Final Design and Project Management support for the development and delivery of OEM solutions.
- Tooling/Mold-Making with a large resource base for design and manufacturing of tooling needs.
- Industrial Design staff will develop your new products to the highest of OEM expectations.
- Quick response time to quotes and involvement with customers.
- Offshore partnerships for regional opportunities.

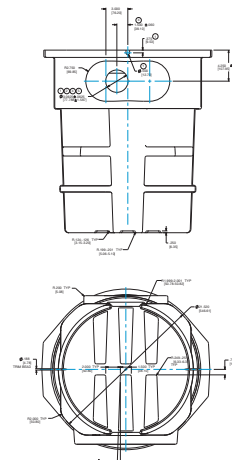

Custom Molding

Akro-Mils' diverse manufacturing capabilities provide total solutions for custom products. With 5 thermoplastics processes, an extensive resin/colorant selection, and a variety of secondary operations, we match your product to the most effective process for optimal performance and cost efficiency.

- Injection Molding (large & small tonnage)
- Structural Foam Molding
- Rotational Molding
- Thermoforming
- Blow Molding



Fabrication – Metal & Wood

Our custom fabricated solutions are designed and built with quality, performance and cost-efficiency in mind. With a wide range of metal and wood fabrication capabilities, Akro-Mils can provide a custom solution to meet your exact needs.



OEM Solutions

Whether customizing our standard products to meet your specific needs or creating a completely new system, Akro-Mils provides a wide range of options for adapting our products to your primary packaging – or adding value as components of your own products.

- Hot Stamping
- Custom Colors
- Private Labeling
- Sequential Numbering
- Custom Dunnage
- Custom Shipping Cartons
- Product Development for Your Specific Application



Merchandising Systems

From 3-D Plan-O-Grams to unique point-of-purchase displays, Akro-Mils will meet your merchandising challenges. Our multiple design options and product configurations provide the creative components you need to maximize space, create eye-catching retail displays, and grow your sales.

- Small Parts Sorting and Display Systems
- Large, Bulk Merchandising Systems
- Bin and Rack Organizing Systems
- Storage Cabinet Systems
- Bin and Tote Shelving Systems
- Mobile, Hanging and Freestanding Product Configurations
- Custom Colors
- Labeling and Graphics Displays

